

016

Wundhaken,
Wundspreizer,
Bauchdeckenhalter
Retractors, Self-retaining
Retractors, Abdominal
Retractors
Separadores, Separadores
autoestáticos,
Separadores abdominales
Divaricatori, Divaricatori
autostatici, Divaricatori
addominali



016

Wundhaken
Retractors
Separadores
Divaricatori

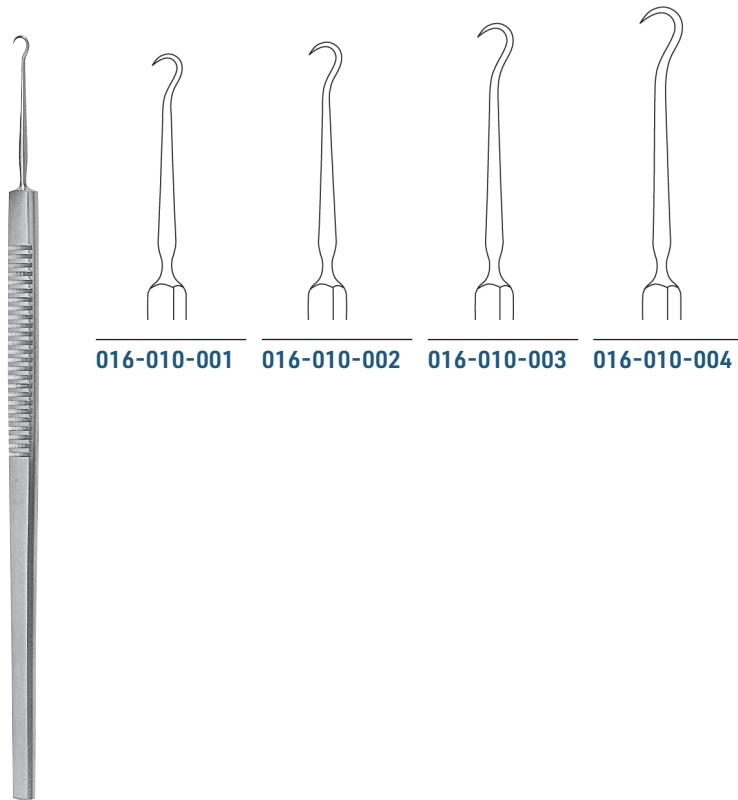

016-010-001 016-010-002 016-010-003 016-010-004

016-010-001 - 016-010-004 16,0 cm / 6 1/4"

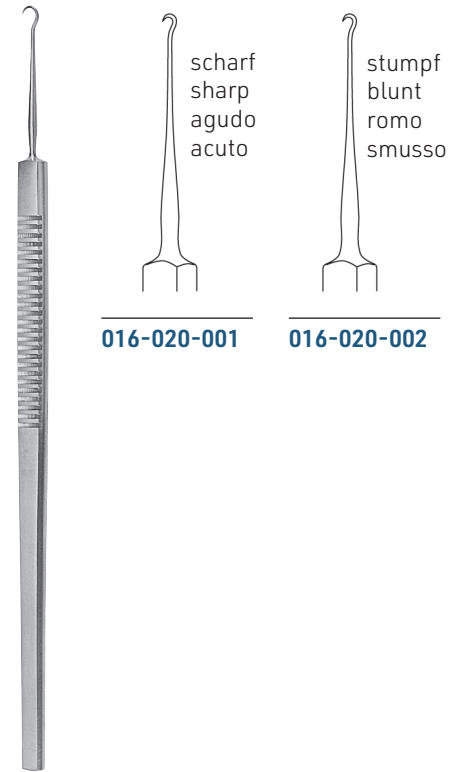

scharf
sharp
agudo
acuto

stumpf
blunt
romo
smusso

016-020-001 016-020-002

GRAEFE

016-020-001 - 016-020-002 15,0cm / 6"

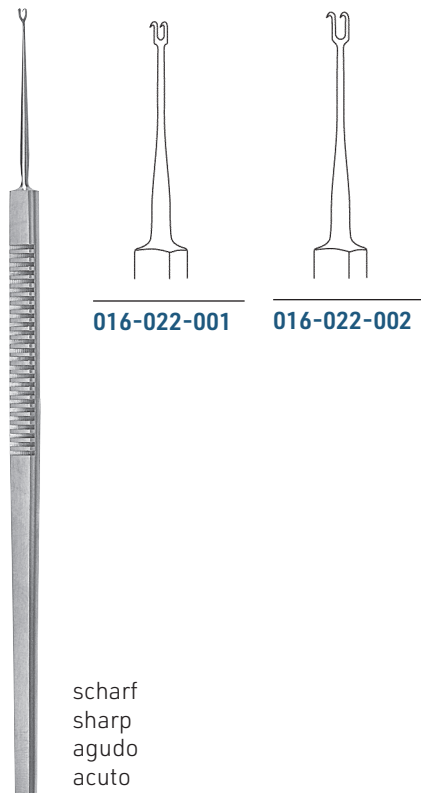

016-022-001 016-022-002

scharf
sharp
agudo
acuto

GUTHRIE

016-022-001 - 016-022-002 15,5 cm / 6 1/4"



O`CONNOR

016-024-160 16,0 cm / 6 1/4"

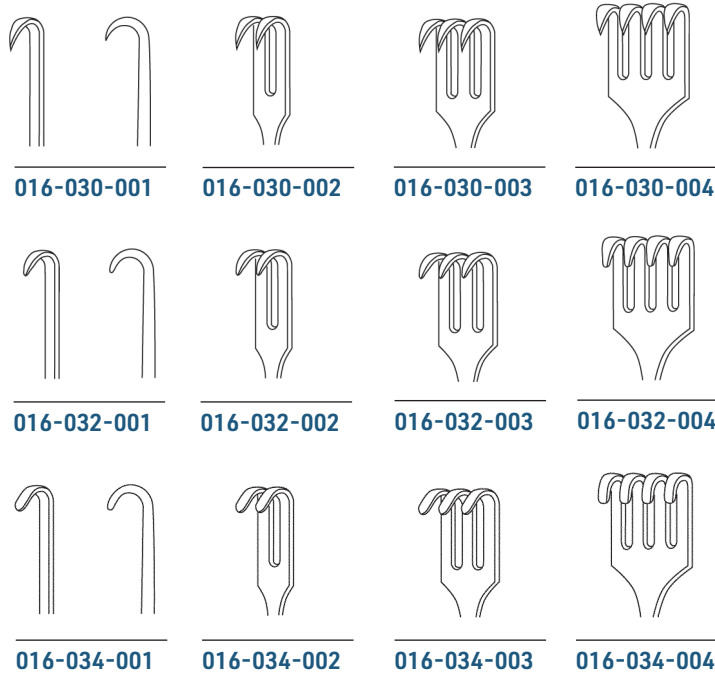

scharf
sharp
agudo
acuto

halbscharf
semi-sharp
semi-agudo
semi-acuto

stumpf
blunt
romo
smusso

016-030-001 - 016-034-004 16,0 cm / 6 1/4"

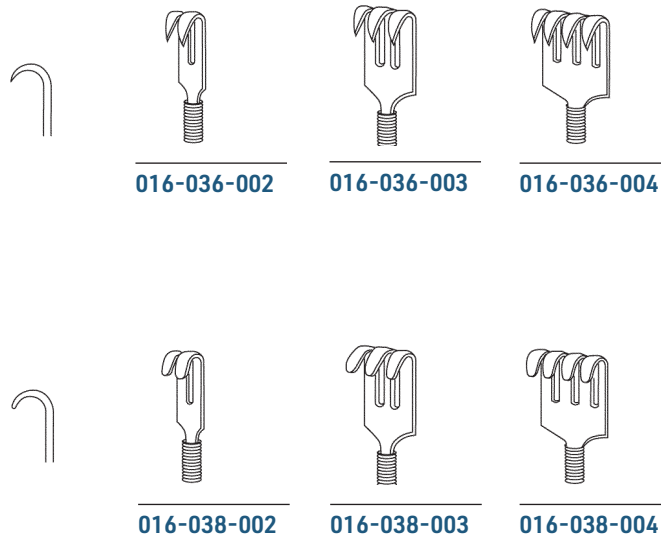

scharf
sharp
agudo
acuto

stumpf
blunt
romo
smusso

flexibel, flexible, flexibles, flessibili

016-036-002 - 016-038-004 16,0 cm / 6 1/4"



016

Wundhaken
Retractors
Separadores
Divaricatori



016-040-001 Fig.1

scharf
sharp
agudo
acuto



016-040-002 Fig.2

stumpf
blunt
romo
smusso



KNAPP

016-040-001 - 016-040-002 13,0 cm / 5"



016-050-008 8,0 mm



016-050-010 10,0 mm



016-050-012 12,0 mm

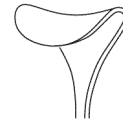

016-050-014 14,0 mm

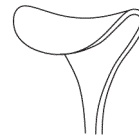

016-050-016 16,0 mm

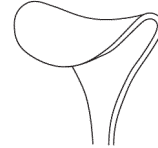

016-050-018 18,0 mm

DESMARRES

016-050-008 - 016-050-018 16,0 cm / 6 1/4"

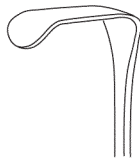

016-056-001 10x6 mm

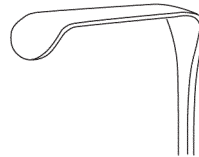

016-056-002 17x5 mm

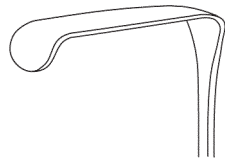

016-056-003 20x6 mm

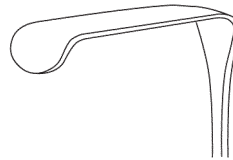

016-056-004 22x8 mm

MINI-LANGENBECK

016-056-001 - 016-056-004 16,0 cm, 6 1/4"



016-058-160 14x8 mm

stumpf
blunt
romo
smusso

16,0 cm, 6 1/4"

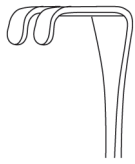

016-060-001 18x7 mm

016-060-002 16x5 mm

016-060-003 7x4 mm

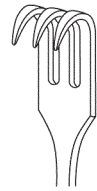
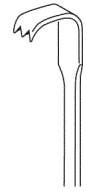

016-060-004 10x3 mm

016-060-005 7x4 mm

016-060-006 10x4 mm

MEYERDING

016-060-001 - 016-060-006 16,0 cm / 6 1/4"



scharf
sharp
agudo
acuto



016-070-001

016-070-002

016-070-003

016-070-004

Kehlengriff
serrated handle
mango serrado
manico striate

stumpf
blunt
romo
smusso

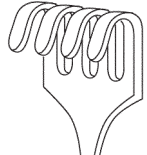
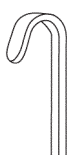

016-071-001

016-071-002

016-071-003

016-071-004

016-070-001 - 016-071-004 16,5 cm, 6 1/2"



016

Wundhaken
Retractors
Separadores
Divaricatori

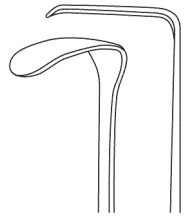

016-072-001 16x6 mm

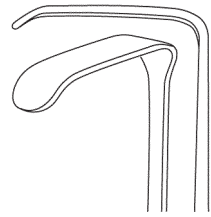

016-072-002 24x6 mm

LANGENBECK-GREEN

016-072-001 - 016-072-002 15,0 cm / 6"



016-074-001 10x6 mm



016-074-002 20x6 mm

016-074-001 - 016-074-002 15,0 cm / 6"



RAGNELL-DAVIS

016-076-140 14,0 cm / 5 1/2"



RAGNELL

016-078-150 15,0 cm / 6"

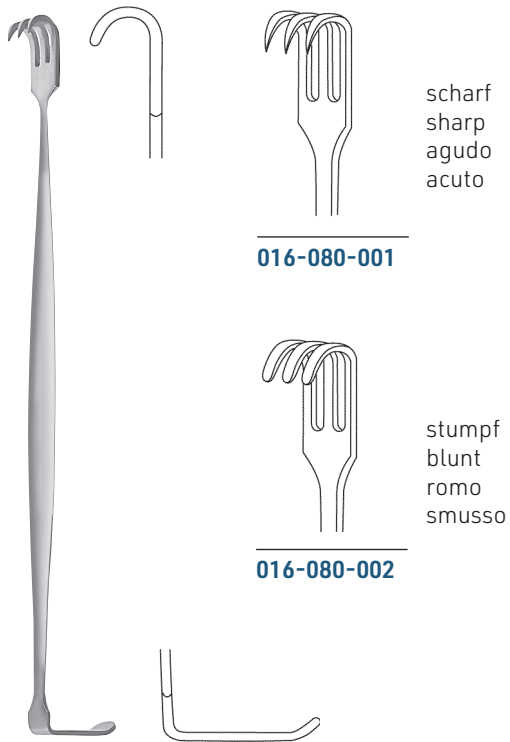

scharf
sharp
agudo
acuto

016-080-001

stumpf
blunt
romo
smusso

016-080-002

SENN-MILLER

016-080-001 - 016-080-002 16,0 cm / 6 1/4"

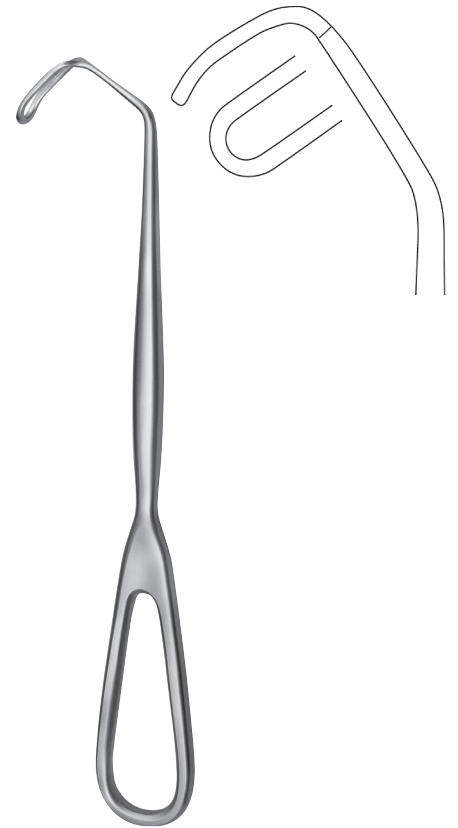

CUSHING

016-090-200 20,0 cm / 8"

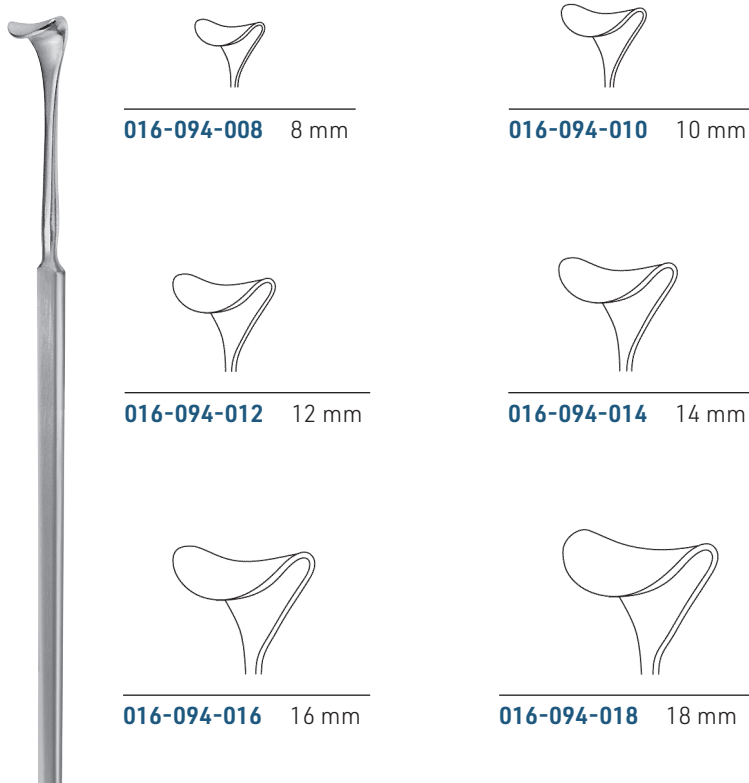

016-094-008 8 mm

016-094-010 10 mm

016-094-012 12 mm

016-094-014 14 mm

016-094-016 16 mm

016-094-018 18 mm

CUSHING

016-094-008 - 016-094-018 20,0 cm / 8"



016

Wundhaken
Retractors
Separadores
Divaricatori



016-096-008 8 mm



016-096-010 10 mm



016-096-012 12 mm



016-096-014 14 mm

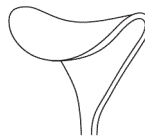

016-096-016 16 mm

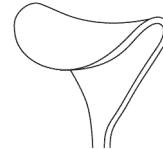

016-096-018 18 mm

CUSHING

016-096-008 - 016-096-018 24,0 cm / 9 1/2"

flexibel
flexible
flexibles
flessibili



GIL-VERNET

016-100-008 - 016-100-023 24,0 cm / 9 1/2"



016-110-001

Fig. 1
glatt
smooth
lisa
liscio

016-110-002

Fig. 2
gezahnt
toothed
dentado
dentate

STRANDELL-STILLE

016-110-001 - 016-110-002 19,0 cm / 7 1/2"



CUSHING

016-114-215 21,5 cm / 8 1/2"



016

Wundhaken
Retractors
Separadores
Divaricatori

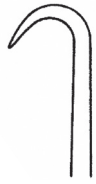

016-120-001

scharf
sharp
agudo
acuto



016-120-002



016-120-003



016-120-004

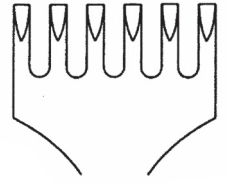

016-120-006

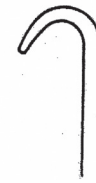

016-122-001

stumpf
blunt
romo
smusso



016-122-002



016-122-003



016-122-004

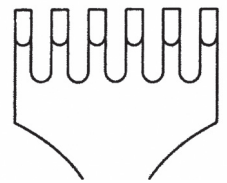

016-122-006

VOLKMANN

016-120-001 - 016-122-006

21,5 cm / 8 1/2"

scharf
sharp
agudo
acuto



016-130-001



016-130-004 9x19 mm

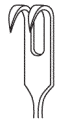

016-130-002 9x8 mm

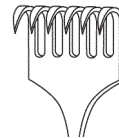

016-130-006 9x29 mm



016-130-003 9x13 mm

VOLKMANN

016-130-001 - 016-130-006

22,0 cm / 8 1/2"

halbscharf
semi-sharp
semi-agudo
semi-acuto



016-132-001



016-132-004 9x19 mm



016-132-002 9x8 mm

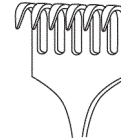

016-132-006 9x29 mm



016-132-003 9x13 mm

VOLKMANN

016-132-001 - 016-132-006 22,0 cm / 8³/₄"

stumpf
blunt
romo
smusso

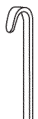

016-134-001



016-134-004 9x19 mm

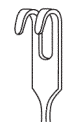

016-134-002 9x8 mm

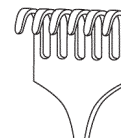

016-134-006 9x29 mm

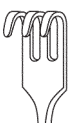

016-134-003 9x13 mm

VOLKMANN

016-134-001 - 016-134-006 22,0 cm / 8³/₄"



016

Wundhaken
Retractors
Separadores
Divaricatori

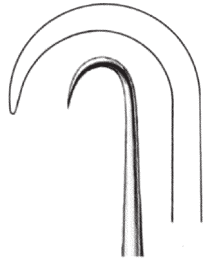

016-136-001
scharf
sharp
agudo
acuto

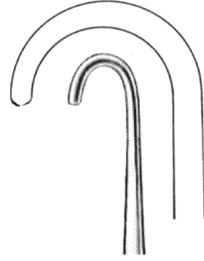

016-136-002
stumpf
blunt
romo
smusso



016-137-001
scharf
sharp
agudo
acuto

VOLKMANN

016-136-001 - 016-137-001 21,5 cm / 8 1/2"

scharf
sharp
agudo
acuto

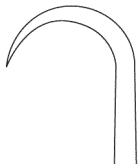

016-140-001



016-140-004 15x20 mm



016-140-002 9x8 mm

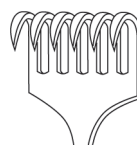

016-140-006 15x30 mm



016-140-003 15x15 mm

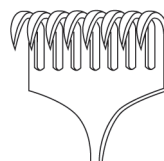

016-140-008 15x40 mm

KOCHER

016-140-001 - 016-140-008 22,0 cm / 8 5/8"

halbscharf
semi-sharp
semi-agudo
semi-acuto

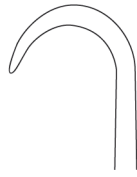

016-142-001



016-142-004 15x20 mm



016-142-002 9x8 mm

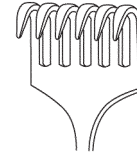

016-142-006 15x30 mm



016-142-003 15x15 mm

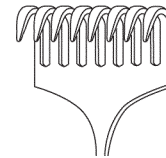

016-142-008 15x40 mm

KOCHER

016-142-001 - 016-142-008 22,0 cm / 8⁵/₈"

stumpf
blunt
romo
smusso

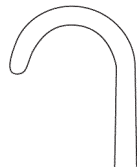

016-144-001

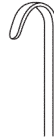

016-144-004 15x20 mm



016-144-002 9x8 mm

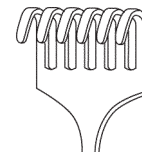

016-144-006 15x30 mm



016-144-003 15x15 mm

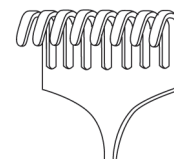

016-144-008 15x40 mm

KOCHER

016-144-001 - 016-144-008 22,0 cm / 8⁵/₈"



016

Wundhaken
Retractors
Separadores
Divaricatori



OLLIER

016-150-003 23,0 cm / 9" 36x30 mm



OLLIER

016-150-004 23,0 cm / 9" 36x60 mm



WASSMUND

016-155-002 20,5 cm / 8" 33x21 mm

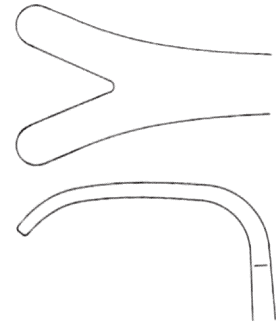

KOERTE

016-160-008 24,0 cm / 9 1/2"

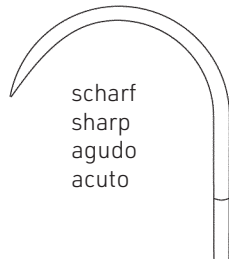

scharf
sharp
agudo
acuto



KOERTE

016-161-008 24,0 cm / 9 1/2"

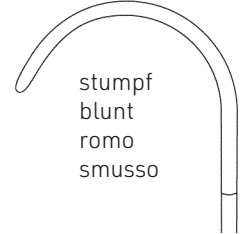

stumpf
blunt
romo
smusso



stumpf
blunt
romo
smusso

ISRAEL

016-166-040 - 016-166-070 25,0 cm / 9³/₄"

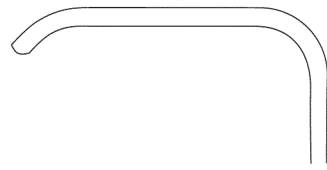

016-166-040 40x40 mm

4 Zähne
4 teeth
4 dientes
4 denti

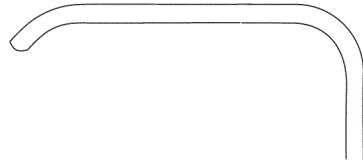

016-166-050 45x50 mm

5 Zähne
5 teeth
5 dientes
5 denti

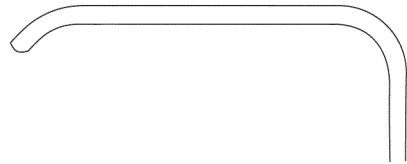

016-166-060 50x60 mm

6 Zähne
6 teeth
6 dientes
6 denti

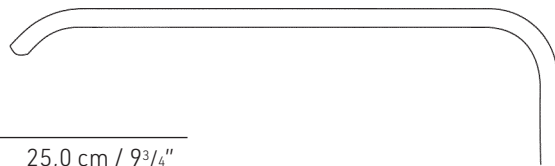

016-166-070 70x70 mm

6 Zähne
6 teeth
6 dientes
6 denti

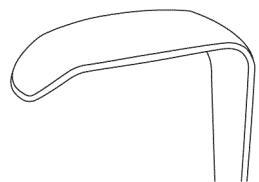

016-170-001 30x11 mm

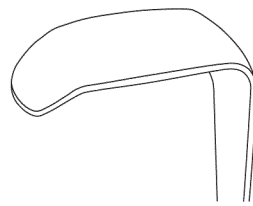

016-170-002 30x14 mm

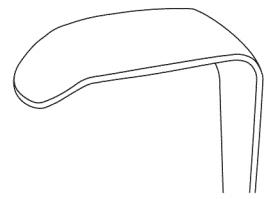

016-170-003 30x16 mm

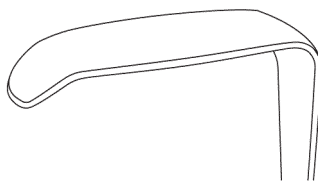

016-170-004 40x11 mm

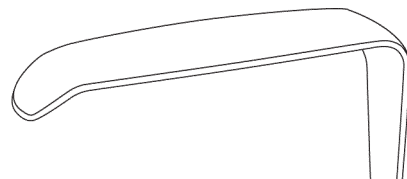

016-170-005 50x11 mm

LANGENBECK

016-170-001 - 016-170-005 22,5 cm / 9"



016

Wundhaken
Retractors
Separadores
Divaricatori

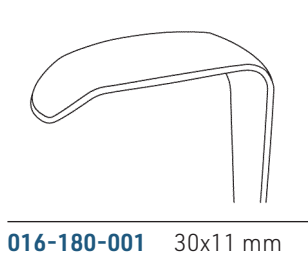

016-180-001 30x11 mm

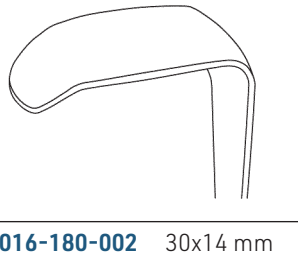

016-180-002 30x14 mm

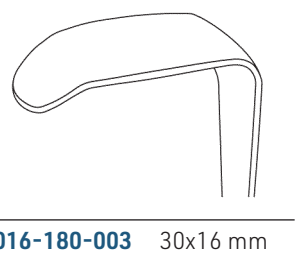

016-180-003 30x16 mm

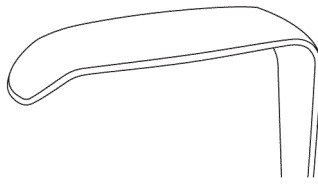

016-180-004 40x11 mm

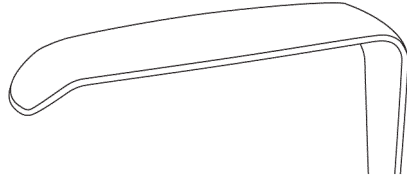

016-180-005 50x11 mm

LANGENBECK

016-180-001 - 016-180-005 22,0 cm / 8⁵/₈"



85x15 mm



60x20 mm

LANGENBECK

016-182-210 21,0 cm / 8¹/₄"



LANGENBECK

016-183-210 22,5 cm / 9"



LAHEY
016-190-190 19,0 cm / 7½"



LITTLE
016-192-200 20,0 cm / 8"



016

Wundhaken
Retractors
Separadores
Divaricatori



KOCHER-LANGENBECK

016-200-001 - 016-200-010 21,5 cm / 8½"

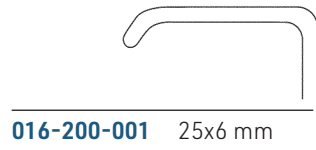

016-200-001 25x6 mm

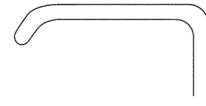

016-200-002 30x11 mm

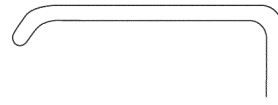

016-200-003 35x8 mm

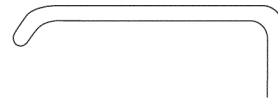

016-200-004 35x11 mm

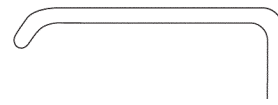

016-200-005 35x15 mm

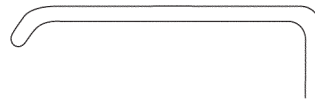

016-200-006 40x11 mm

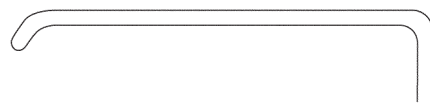

016-200-007 55x11 mm

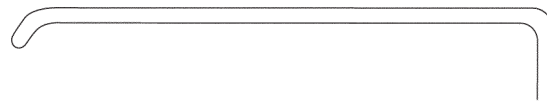

016-200-008 70x15 mm

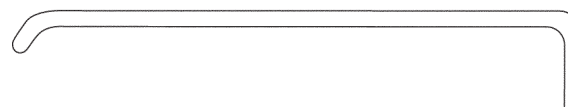

016-200-009 80x12 mm

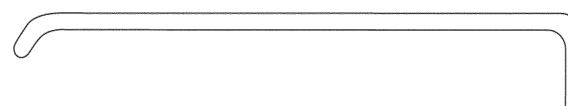

016-200-010 80x15 mm



KOCHER

016-210-018 - 016-210-040 21,0 cm / 8¹/₄"

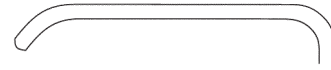

016-210-018 40x18 mm

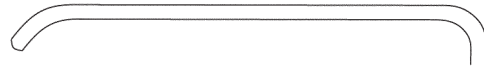

016-210-020 60x20 mm

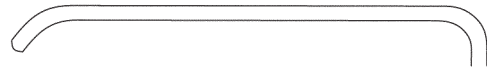

016-210-025 60x25 mm

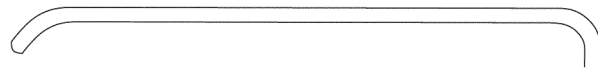

016-210-030 75x30 mm

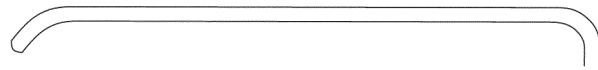

016-210-040 75x40 mm



SAUERBRUCH

016-220-001 - 016-220-003 22,5 cm / 8³/₄"

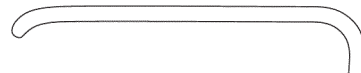

016-220-001 50x15 mm

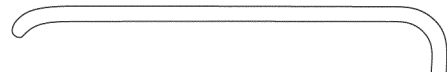

016-220-002 63x23 mm

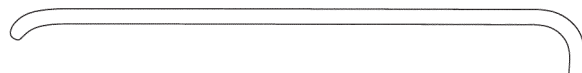

016-220-003 80x20 mm



016

Wundhaken
Retractors
Separadores
Divaricatori



ZENKER

016-230-001	25,0 cm / 9 ³ / ₄ "
016-230-002	26,0 cm / 10"
016-230-003	27,5 cm / 10 ³ / ₄ "

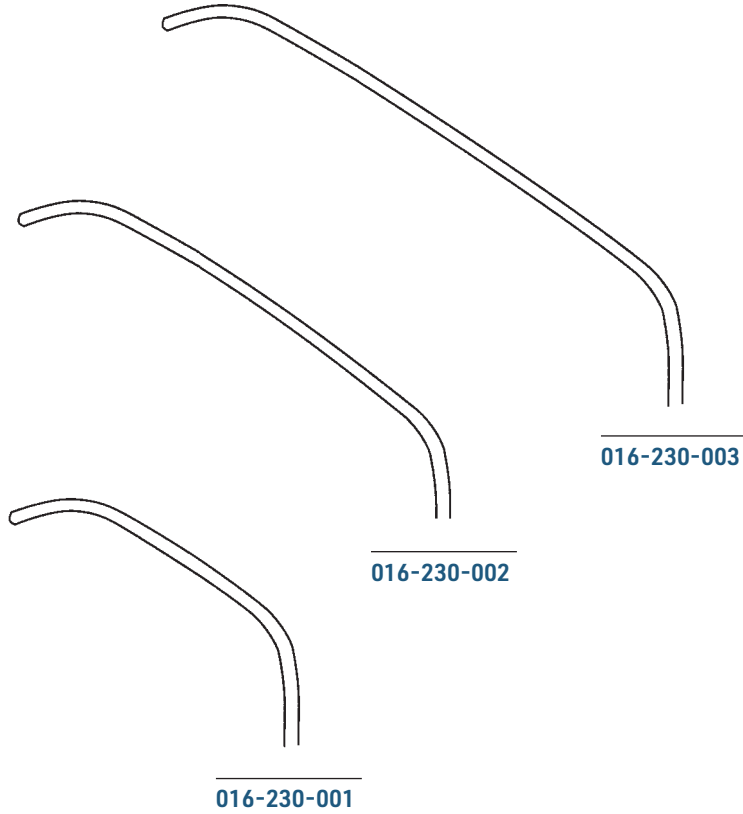

KOCHER

016-240-012	19,0 cm / 7 ¹ / ₂ "	19 x 12 mm
016-240-014	19,0 cm / 7 ¹ / ₂ "	21 x 14 mm



KOCHER

016-250-010	22 cm / 8 ⁵ / ₈ "	42x10 mm
016-250-015	22 cm / 8 ⁵ / ₈ "	42x15 mm
016-250-020	22 cm / 8 ⁵ / ₈ "	43x20 mm



016-260-001 18x17 mm

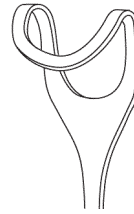

016-260-002 25x22 mm

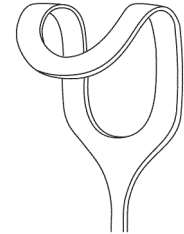

016-260-003 31x30 mm

MIDDELDORPF

016-260-001	21,5 cm / 8 ¹ / ₂ "
016-260-002	23,0 cm / 9"
016-260-003	24,5 cm / 9 ² / ₃ "



016-262-001 14x17 mm

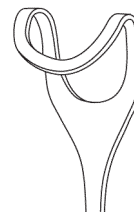

016-262-002 20x22 mm

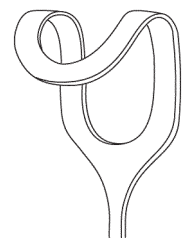

016-262-003 26x30 mm

MIDDELDORPF

016-262-001	21,5 cm / 8 ¹ / ₂ "
016-262-002	22 cm / 8 ⁵ / ₈ "
016-262-003	23,5 cm / 9 ¹ / ₂ "



RICHARDSON-EASTMAN

- 016-270-000** Fig. 1+2 27,0 cm / 10³/₄"
- 016-270-001** Fig. 1 26,0 cm / 10¹/₄"
- 016-270-002** Fig. 2 27,0 cm / 10³/₄"



RICHARDSON

- 016-272-001 - 016-272-004** 24,0 cm / 9¹/₂"



016-272-001 30x21 mm

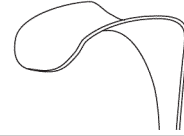

016-272-002 37x29 mm

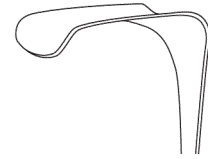

016-272-003 45x40 mm

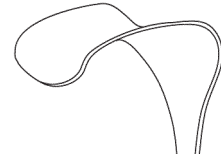

016-272-004 53x22 mm

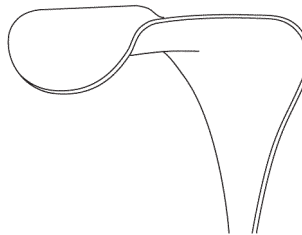

KELLY

- 016-274-001** 26,0 cm / 10¹/₄" 62 x 50 mm

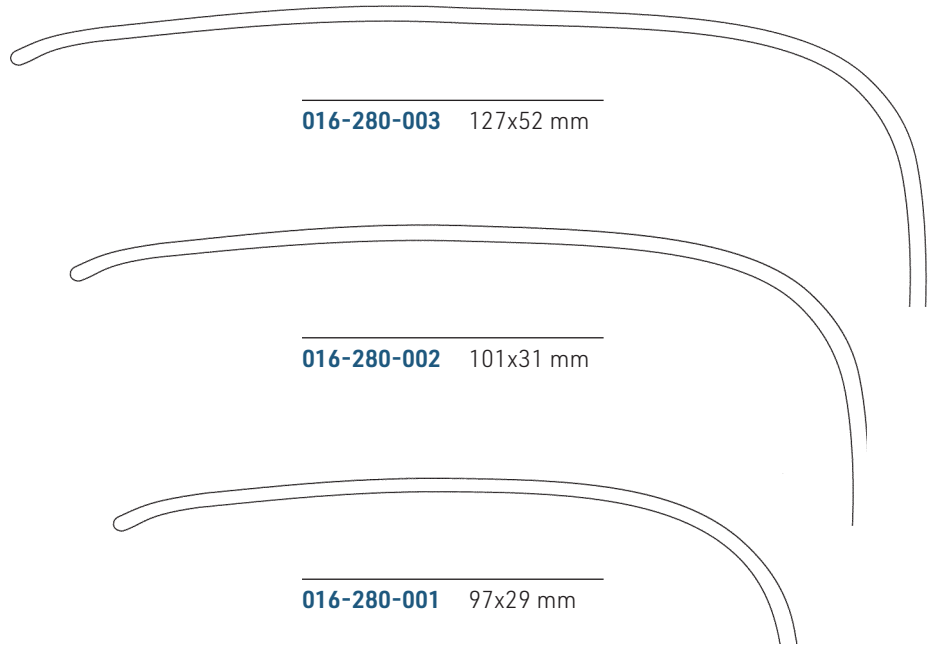
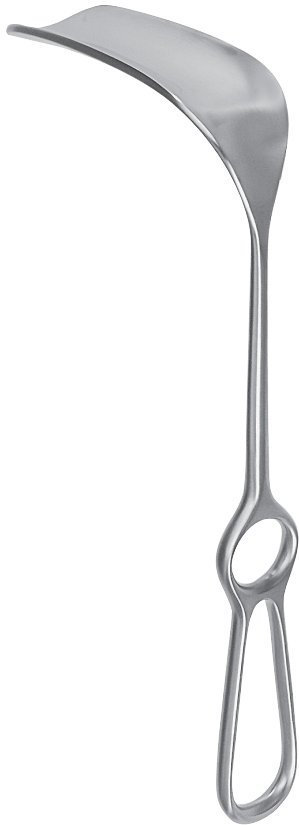

DOYEN-STILLE

016-280-001 - 016-280-003 26,0 cm / 10¹/₄"

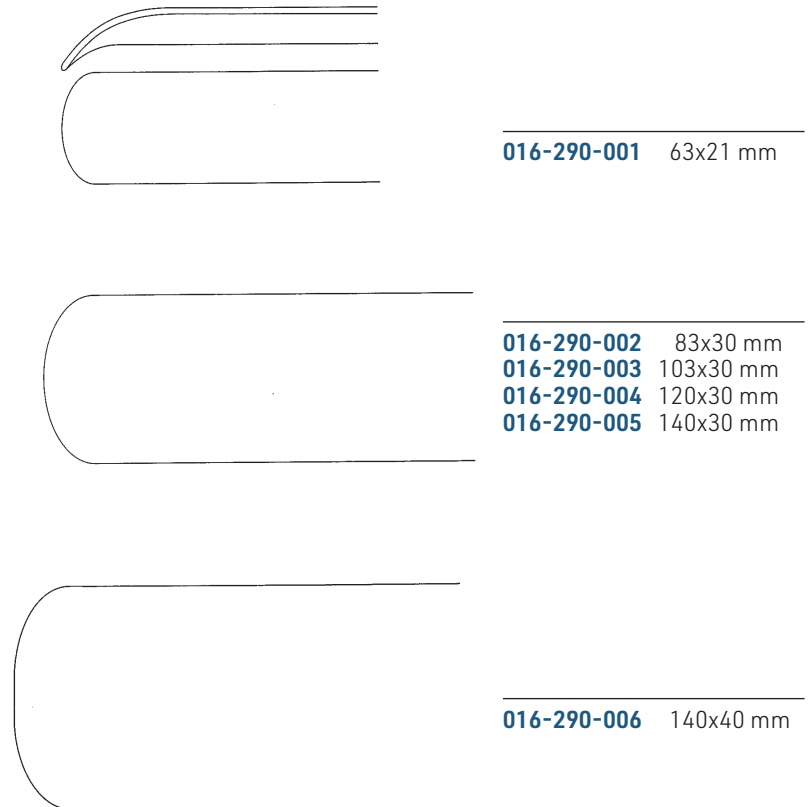

HÖSEL

016-290-001 - 016-290-006 26,0 cm / 10¹/₄"



016

Wundhaken
Retractors
Separadores
Divaricatori

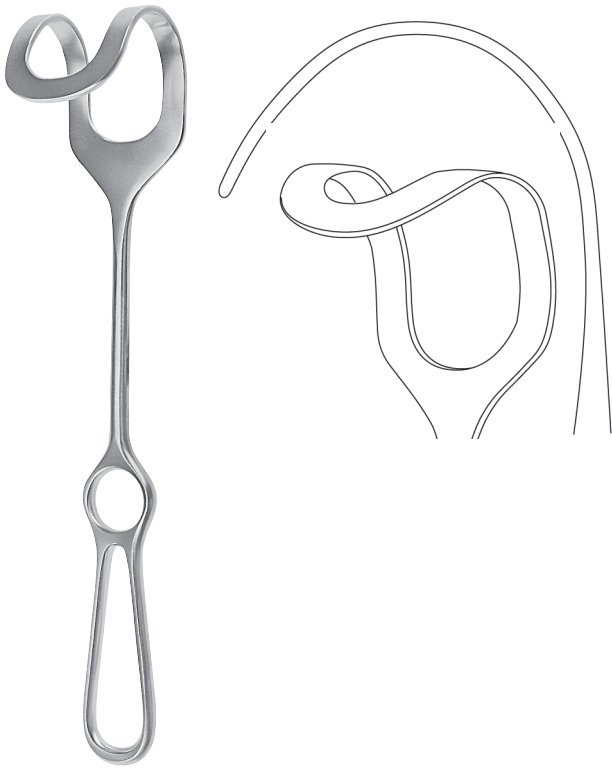

MIDDENDORPF

016-300-001	27,0 cm / 10 ³ / ₄ "	48x45 mm
016-300-002	27,0 cm / 10 ³ / ₄ "	52x50 mm
016-300-003	28,0 cm / 11"	60x70 mm



FRITSCH

016-310-000	23,5 cm / 9 ¹ / ₄ "	30x30 mm
016-310-001	24,0 cm / 9 ¹ / ₂ "	32x40 mm
016-310-002	25,0 cm / 9 ³ / ₄ "	40x50 mm
016-310-003	25,0 cm / 9 ³ / ₄ "	40x60 mm
016-310-004	25,5 cm / 10"	45x75 mm
016-310-005	26,5 cm / 10 ¹ / ₂ "	65x85 mm



DOYEN

016-320-250	25,0 cm / 10"
--------------------	---------------

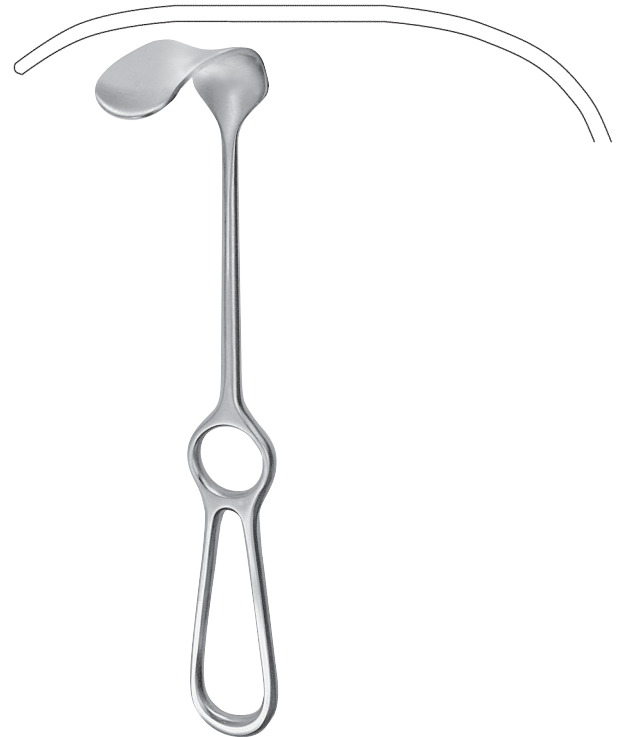

KOCHER

016-324-025	25,0 cm / 10"	70x25 mm
016-324-045	25,0 cm / 10"	80x45 mm
016-324-055	25,0 cm / 10"	80x55 mm
016-324-065	25,0 cm / 10"	80x65 mm

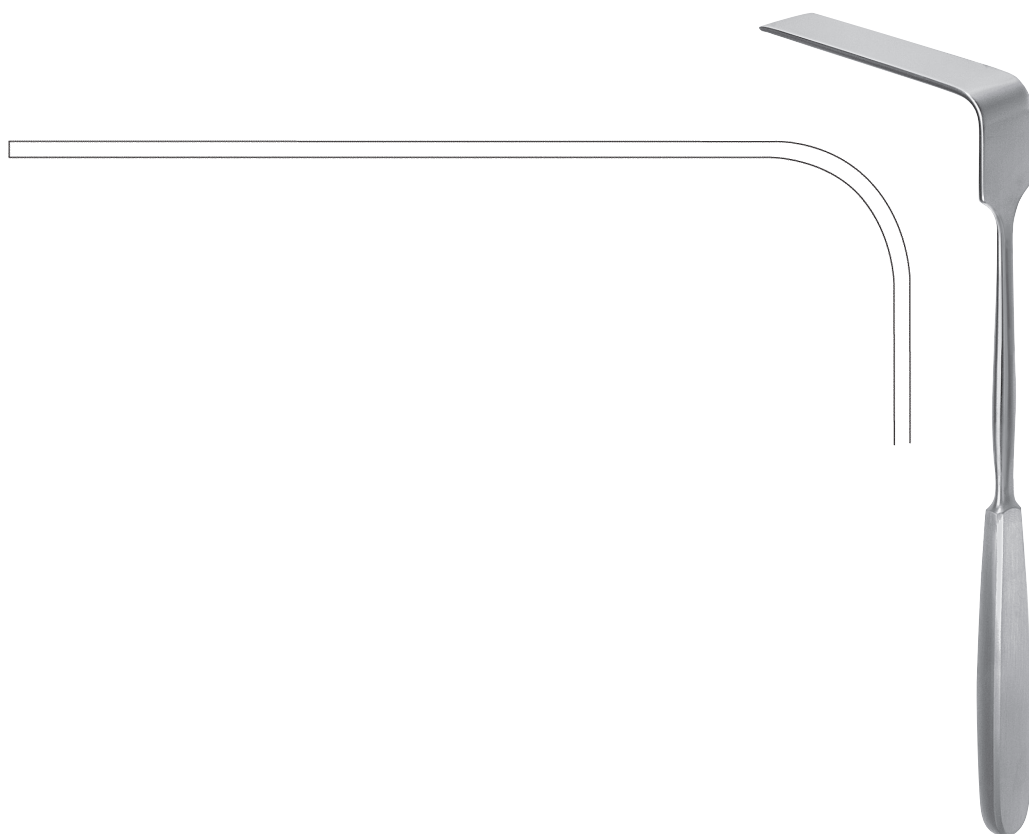

SIMON

016-326-022	28,0 cm / 11"	115x22 mm
016-326-027	28,0 cm / 11"	115x27 mm

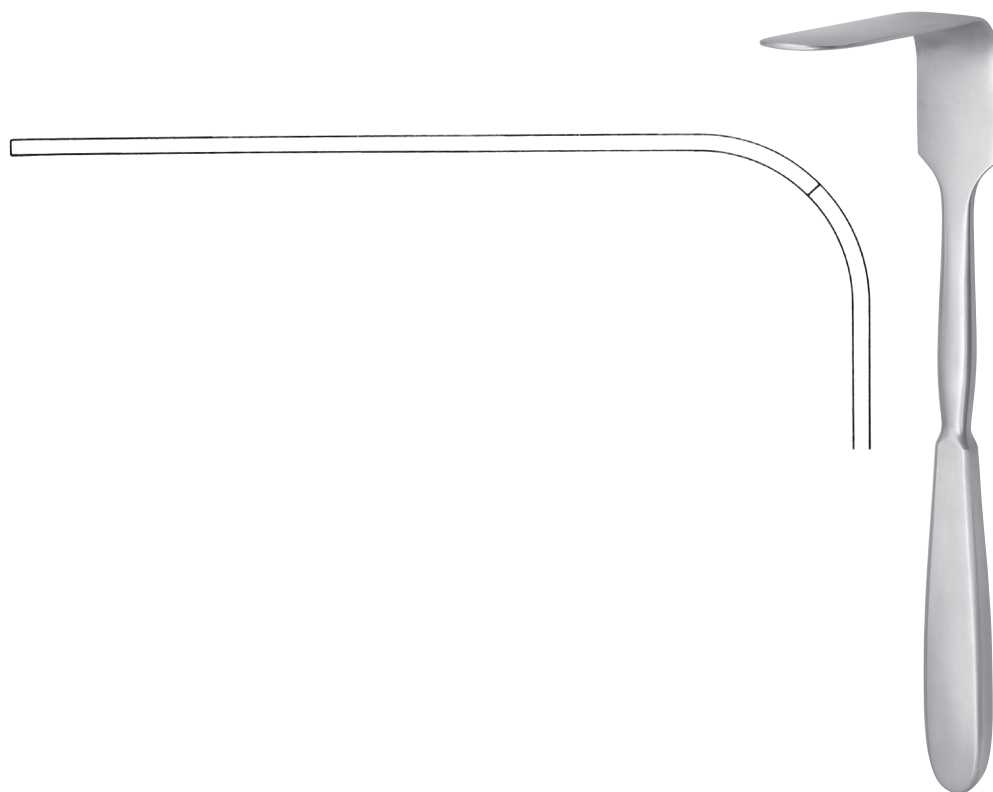

MARTIN

016-328-027	26,0 cm / 10"	110 x 27 mm
--------------------	---------------	-------------



016

Wundhaken
Retractors
Separadores
Divaricatori



CORYLLOS

016-330-001	24,0 cm / 9 ¹ / ₂ "	85x22 mm
016-330-002	24,0 cm / 9 ³ / ₄ "	108x43 mm
016-330-003	24,0 cm / 9 ³ / ₄ "	119x65 mm



DAVIDSON

016-340-001	19,0 cm / 6 ¹ / ₄ "	80x54 mm
016-340-002	18,5 cm / 6 ¹ / ₄ "	80x95 mm



SAUERBRUCH

016-344-250	25,5 cm / 10"	127x38 mm
--------------------	---------------	-----------

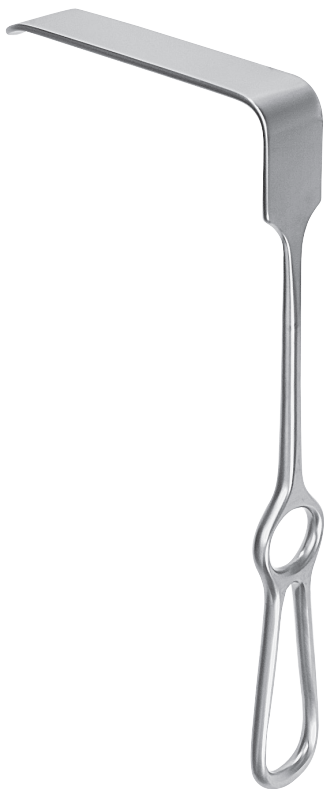
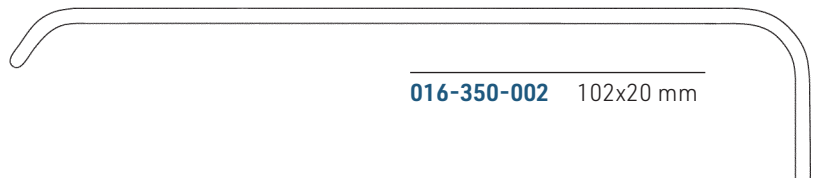
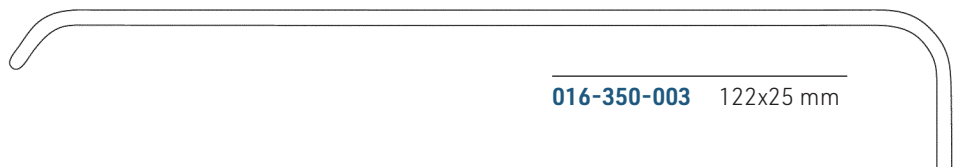
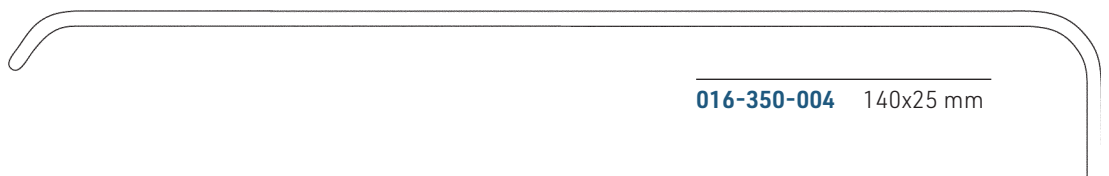
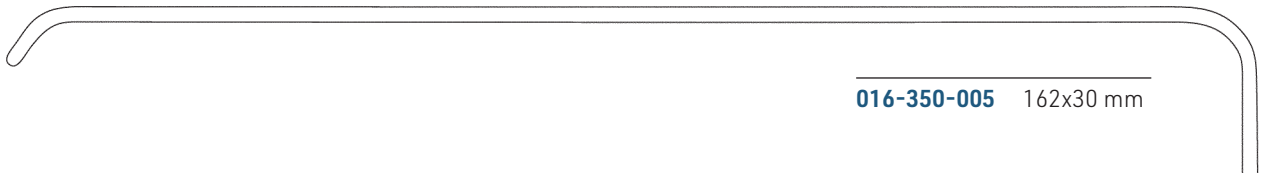
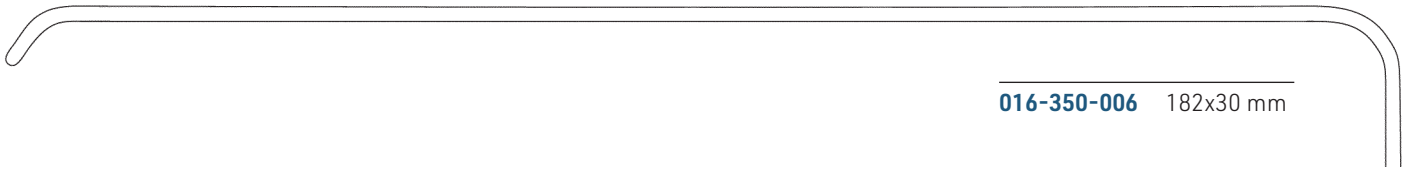

BRUNNER

016-350-001 - 016-350-006 25,0 cm / 9³/₄"



016

Wundhaken
Retractors
Separadores
Divaricatori

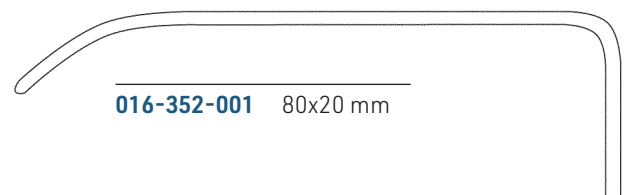
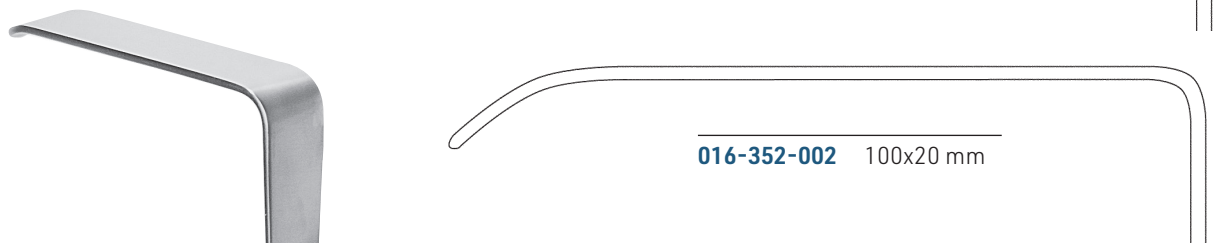
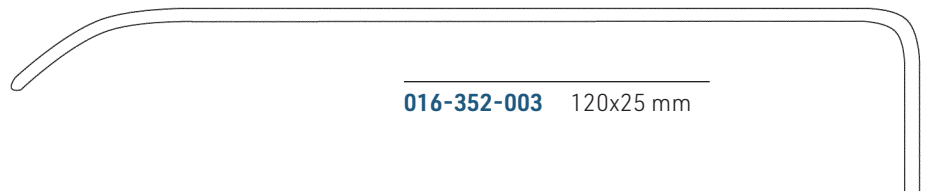
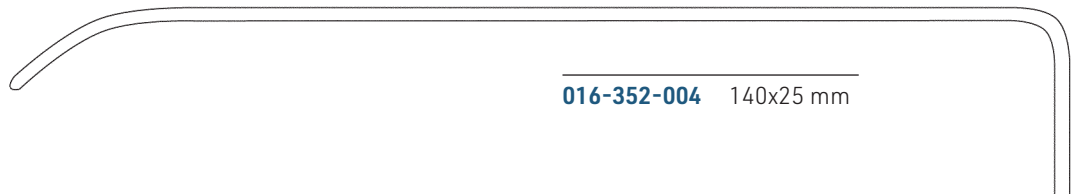
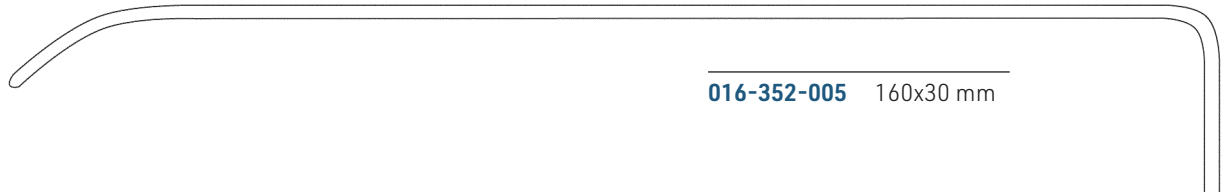

BRUNNER

016-352-001 - 016-352-006 25,0 cm / 9³/₄"

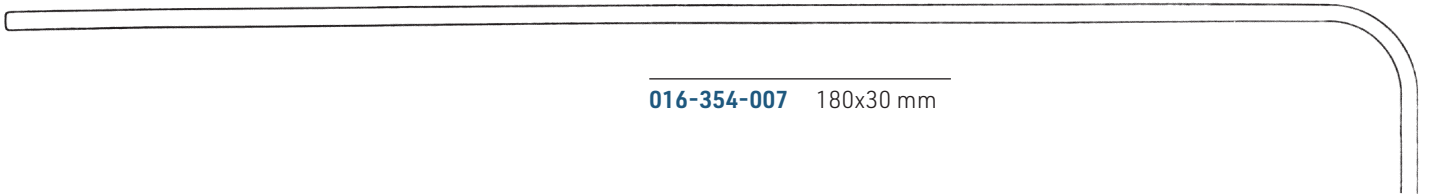

016-354-007 180x30 mm

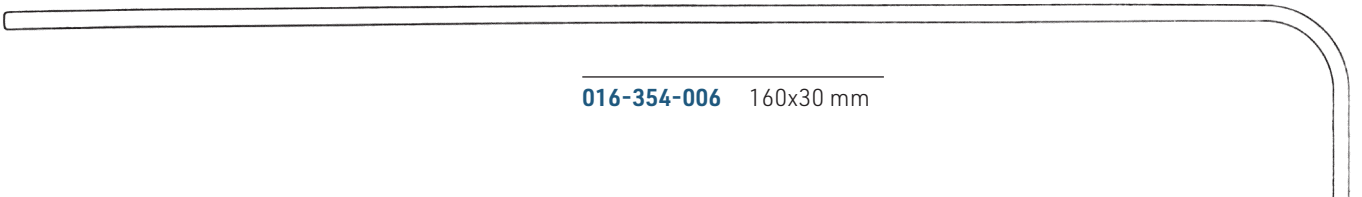

016-354-006 160x30 mm

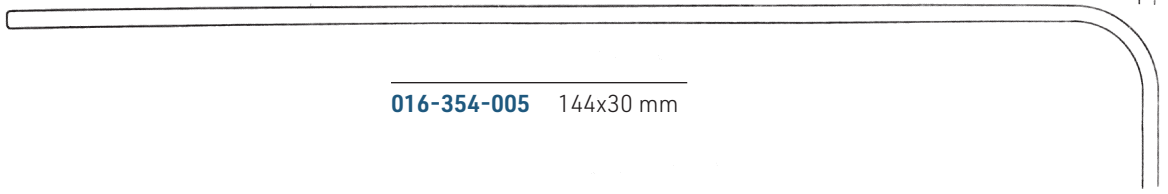

016-354-005 144x30 mm

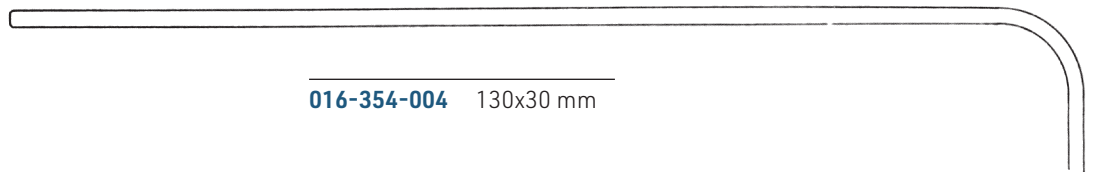

016-354-004 130x30 mm

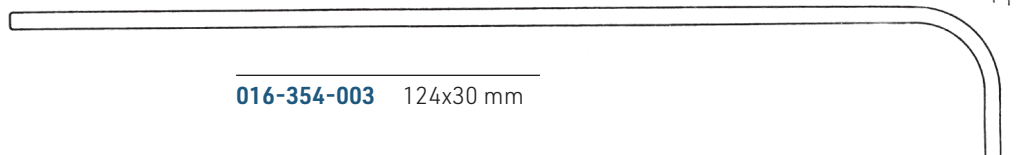

016-354-003 124x30 mm

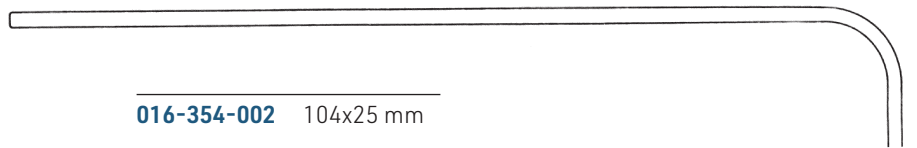

016-354-002 104x25 mm

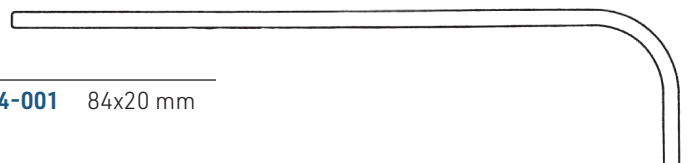

016-354-001 84x20 mm



BRUNNER

016-354-001 - 016-354-007 25,5 cm / 10"



016

Wundhaken
Retractors
Separadores
Divaricatori



016-358-001 15x15 mm

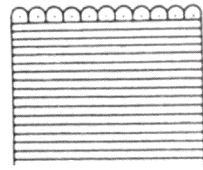

016-358-002 15x23 mm

CRAWFORD

016-358-001 - 016-358-002 19,0 cm / 7¹/₂"



016-360-001 Fig. 1



016-360-002 Fig. 2



016-360-003 Fig. 3



016-360-004 Fig. 4



016-360-005 Fig. 5



016-360-006 Fig. 6

ROSS

016-360-001 - 016-360-006 25,0 cm / 9³/₄"

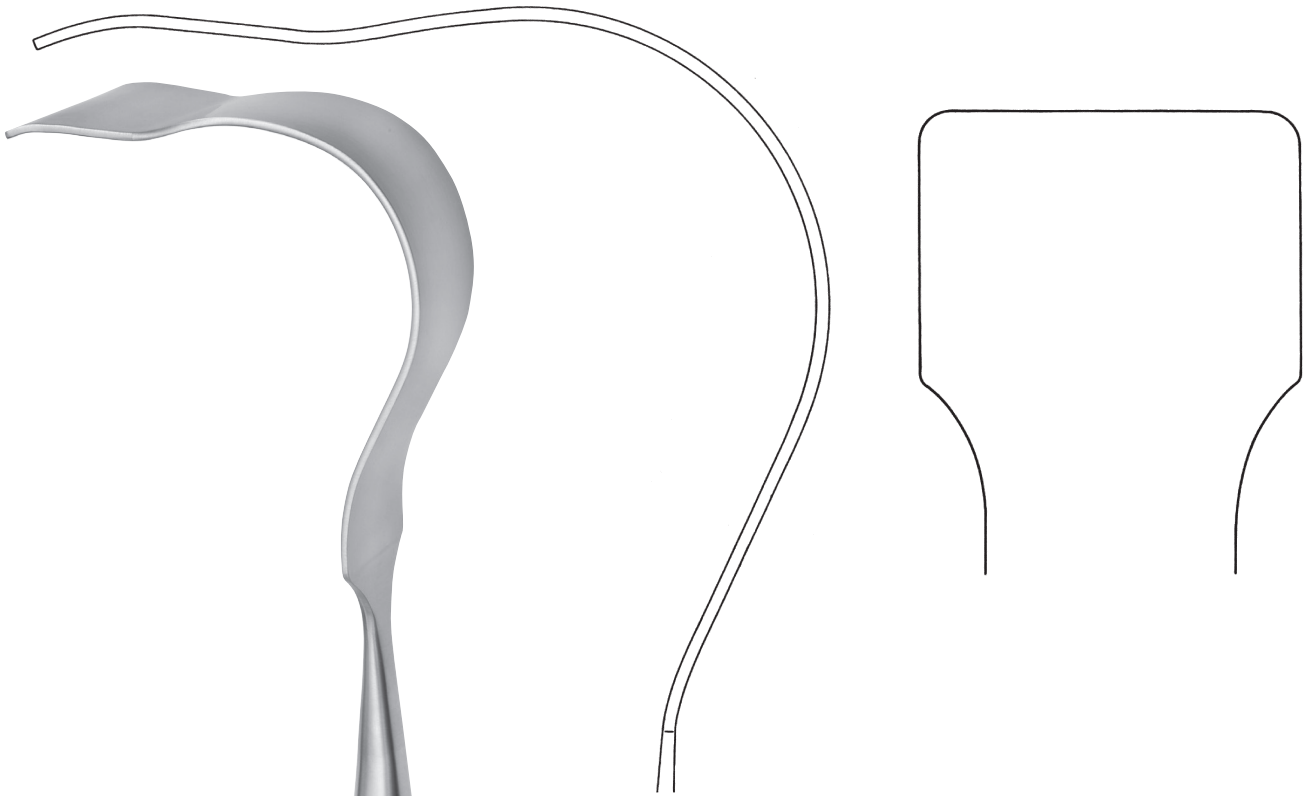

POLLOSON

016-366-001 29,0 cm / 11¹/₂"



POLLOSON

016-366-002 27,0 cm / 10³/₄"



016

Wundhaken
Retractors
Separadores
Divaricatori



HARRINGTON

016-370-001	31,5 cm / 12 ¹ / ₂ "	137x44 mm
016-370-002	31,5 cm / 12 ¹ / ₂ "	137x65 mm



MORRIS

016-380-040	24,5 cm / 9 ² / ₃ "	70x40 mm
016-380-050	24,5 cm / 9 ² / ₃ "	70x50 mm
016-380-065	24,5 cm / 9 ² / ₃ "	70x65 mm



MEYERDING

016-390-001 - 016-390-003 23 cm / 8³/₄"

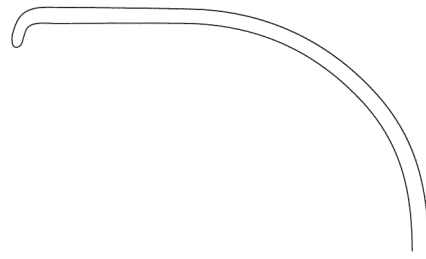

016-390-001 50x16 mm 23,0 cm

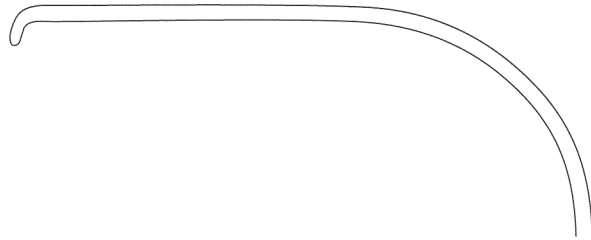

016-390-002 75x25 mm 23,0 cm

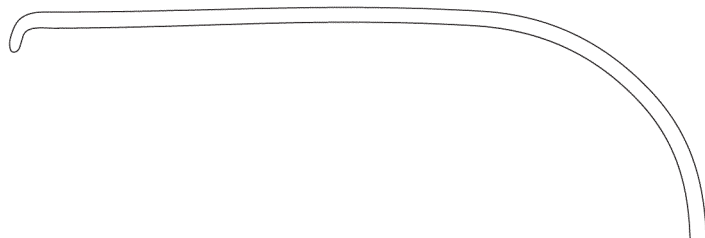

016-390-003 90x50 mm 25,5 cm



19 mm

DEAVER

016-400-001 18,0 cm / 7"



22 mm

DEAVER

016-400-002 21,5 cm / 8¹/₂"



25 mm

DEAVER

016-400-003 25,0 cm / 9³/₄"



016

Wundhaken
Retractors
Separadores
Divaricatori



25 mm

DEAVER

016-400-004 31,0 cm / 12¹/₄"



25 mm

DEAVER

016-400-005 33,0 cm / 13"



25 mm

DEAVER

016-400-006 36,0 cm / 14¹/₈"



38 mm

DEAVER

016-400-007 30,0 cm / 11³/₄"



50 mm

DEAVER

016-400-008 31,0 cm / 12¹/₄"



75 mm

DEAVER

016-400-009 31,5 cm / 12¹/₂"



DEAVER

016-402-025	31,5 cm / 12 1/2"	25 mm
016-402-038	31,5 cm / 12 1/2"	38 mm
016-402-050	31,5 cm / 12 1/2"	50 mm
016-402-075	31,0 cm / 12 1/4"	75 mm



48 x 48 mm
rechts
right
derecho
destra

COOLEY

016-410-001 25,0 cm / 9 3/4"



48 x 48 mm
rechts gerieft
right serrated
derecho, estriado
destra, con striatura

COOLEY

016-410-002 25,0 cm / 9 3/4"



30 x 48 mm
links
left
izquierdo
sinistra

COOLEY

016-410-003 27,0 cm / 10 3/4"



016

Wundhaken
Retractors
Separadores
Divaricatori

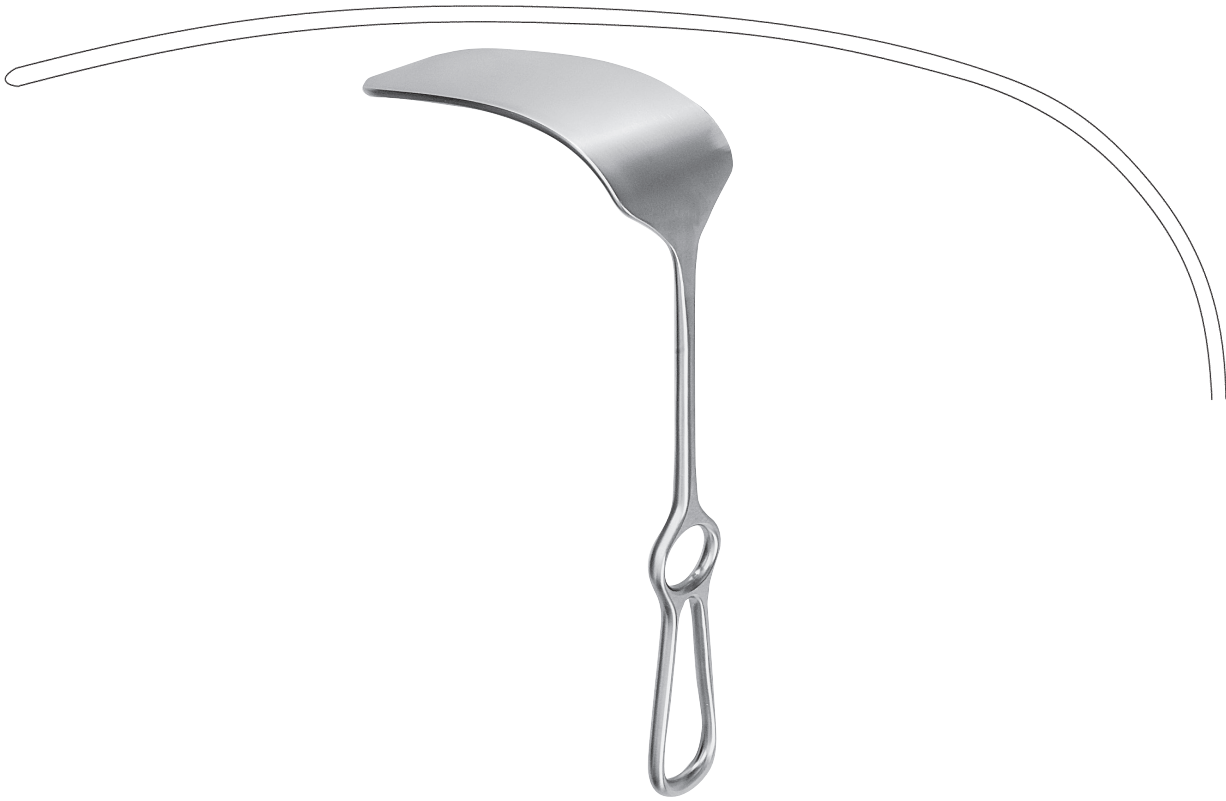

MIKULICZ

016-414-001	25,0 cm / 9 ³ / ₄ "	90x35 mm
016-414-002	25,0 cm / 9 ³ / ₄ "	125 x50 mm
016-414-003	25,0 cm / 9 ³ / ₄ "	160 x50 mm

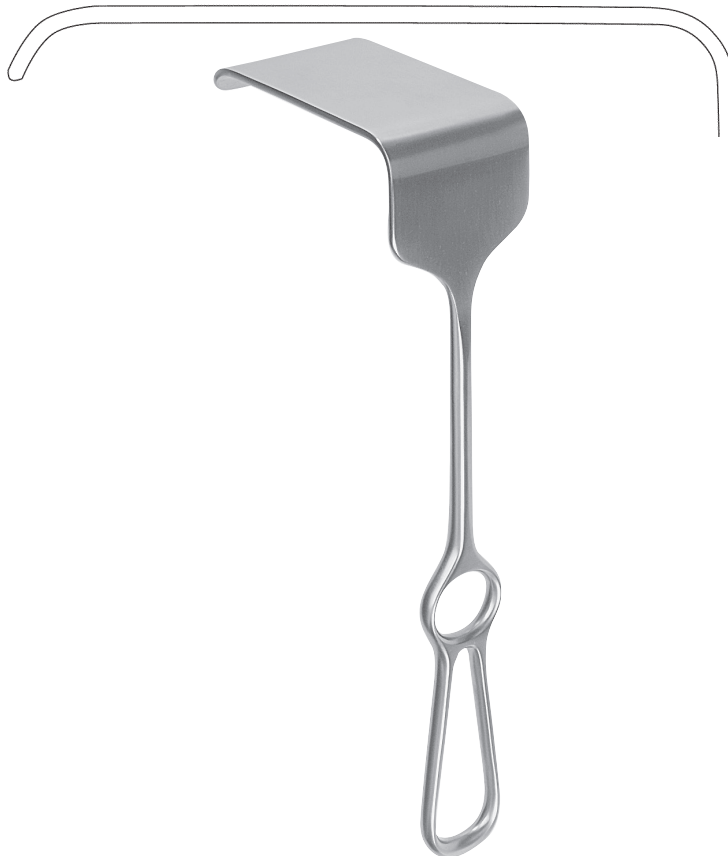

MIKULICZ

016-416-260	26,0 cm / 10 ¹ / ₄ "	90 x 55 mm
--------------------	--	------------



KELLY

016-420-001	27,0 cm / 10 ³ / ₄ "	160x38 mm
016-420-002	27,0 cm / 10 ³ / ₄ "	160x57 mm
016-420-003	27,0 cm / 10 ³ / ₄ "	190x38 mm
016-420-004	27,0 cm / 10 ³ / ₄ "	190x57 mm

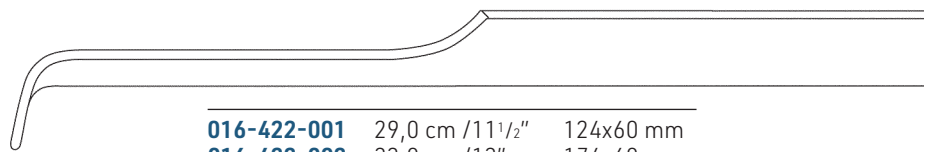

016-422-001	29,0 cm / 11 ¹ / ₂ "	124x60 mm
016-422-002	33,0 cm / 13"	174x60 mm

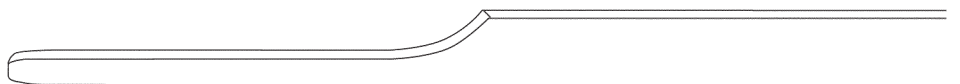

016-422-003	33,0 cm / 13"	178x60 mm
--------------------	---------------	-----------

ST. MARKS

016-422-001 - 016-422-003



016

Wundhaken
Retractors
Separadores
Divaricatori

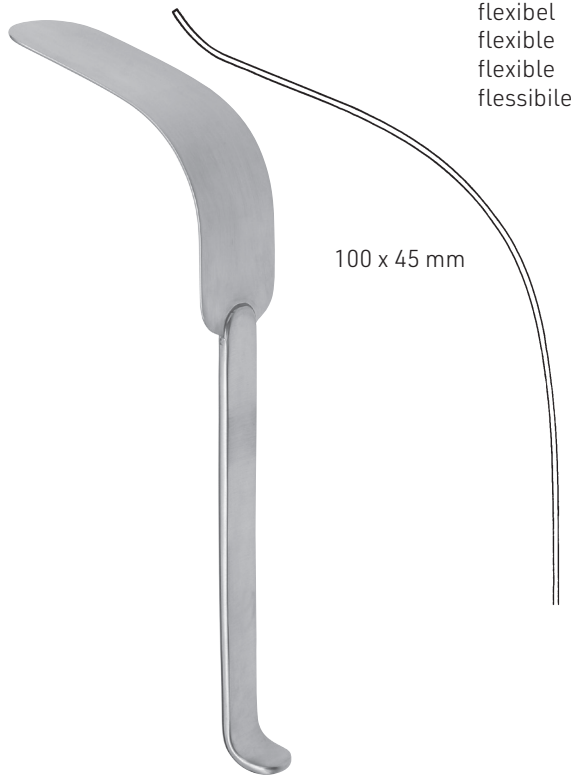

flexibel
flexible
flexible
flessibile

100 x 45 mm

KUEMMEL

016-426-280 28,0 cm / 11"

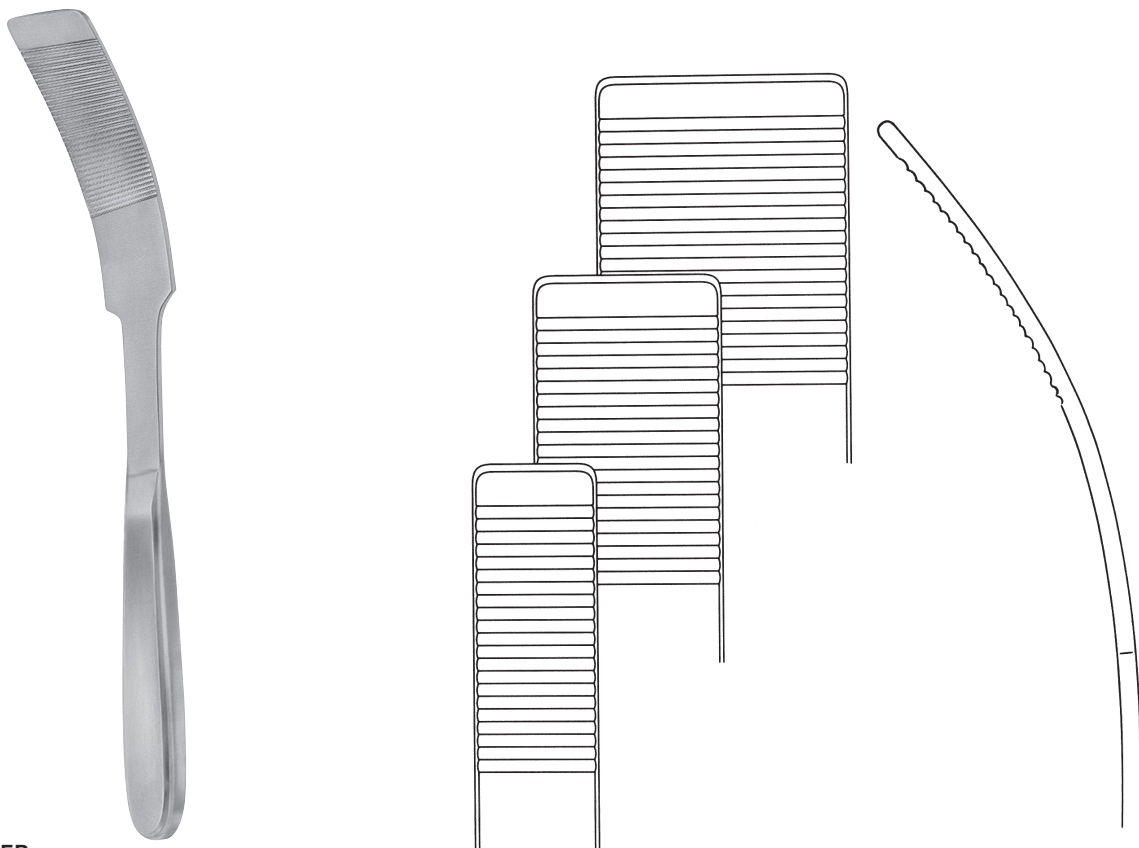

KADER

016-430-020	28,0 cm / 11"	20 mm
016-430-030	28,0 cm / 11"	30 mm
016-430-040	28,0 cm / 11"	40 mm



Fig.1 24x20 mm
Fig.2 29x26 mm
mmFig.3 33x29 mm

Satz, Fig. 1-3
Set, fig. 1-3
Juego, fig. 1-3
Serie, fig. 1-3

Fig.1 30x28 mm
Fig.2 36x36 mm
mmFig.3 38x43 mm

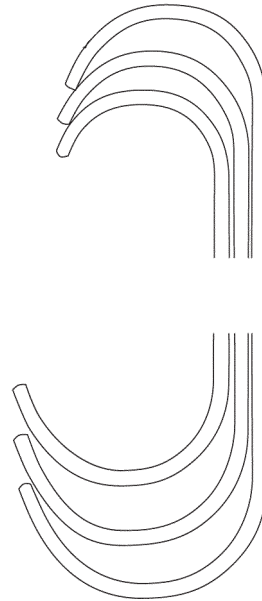

ROUX

016-450-000	17,0 cm / 6 ³ / ₄ "	Fig.1-3
016-450-001	14,0 cm / 5 ¹ / ₂ "	Fig.1
016-450-002	15,0 cm / 6"	Fig.2
016-450-003	17,0 cm / 6 ³ / ₄ "	Fig.3



Fig.2 30x10 mm
Fig.1 26x10 mm

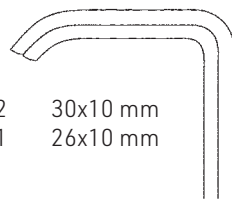
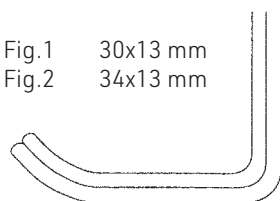

Fig.1 30x13 mm
Fig.2 34x13 mm



FARABEUF

016-454-000	11,5 cm / 4 ¹ / ₄ "	Fig.1-2
016-454-001	11,5 cm / 4 ¹ / ₄ "	Fig.1
016-454-002	11,5 cm / 4 ¹ / ₄ "	Fig.2



Fig.1 23x16 mm
Fig.2 27x16 mm

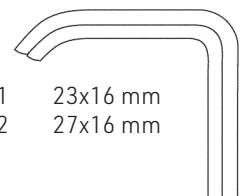
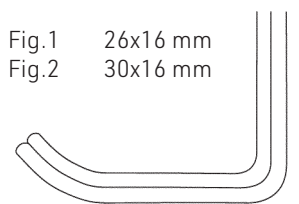

Fig.1 26x16 mm
Fig.2 30x16 mm



FARABEUF

016-456-000	15,0 cm / 6"	Fig.1-2
016-456-001	15,0 cm / 6"	Fig.1
016-456-002	15,0 cm / 6"	Fig.2



016

Wundhaken
Retractors
Separadores
Divaricatori



MINI-ROUX
016-458-140 14,0 cm / 5 1/2"



BABY-ROUX
016-460-130 13,0 cm / 5"

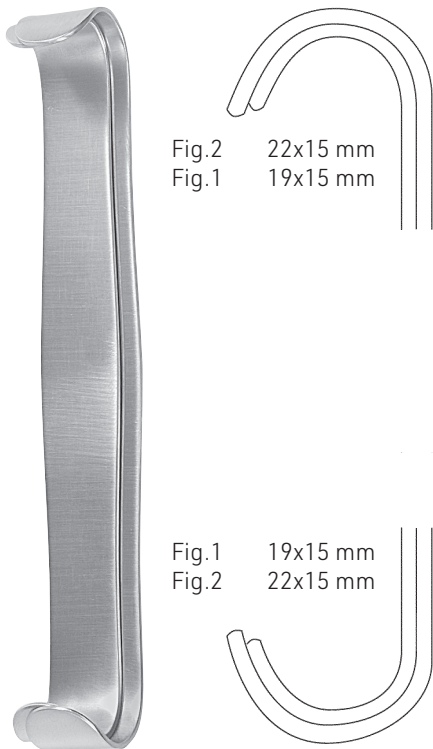

PARKER
016-464-000 13,5 cm / 5 1/4" Fig.1-2
016-464-001 13,5 cm / 5 1/4" Fig.1
016-464-002 13,5 cm / 5 1/4" Fig.2

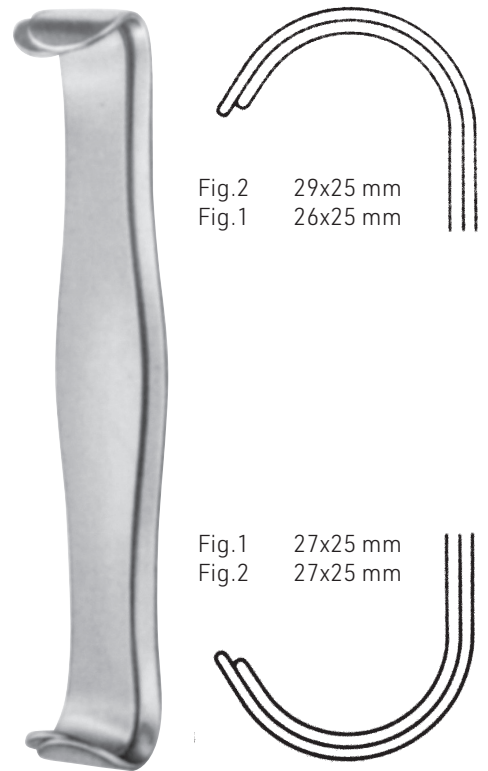

PARKER
016-466-000 17,5 cm / 7" Fig.1-2
016-466-001 17,5 cm / 7" Fig.1
016-466-002 17,5 cm / 7" Fig.2

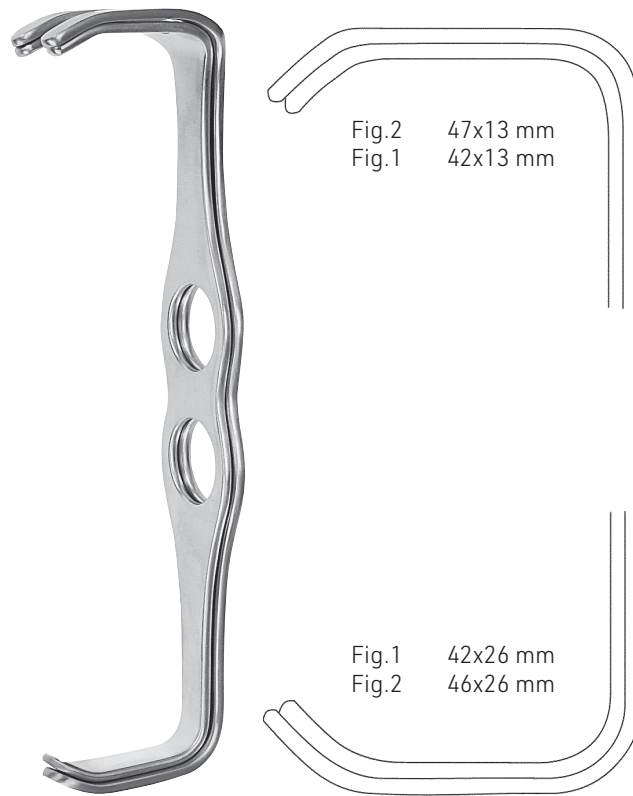

MATHIEU

016-470-000	20,0 cm / 8"	Fig.1-2
016-470-001	20,0 cm / 8"	Fig.1
016-470-002	20,0 cm / 8"	Fig.2



GOELET

016-472-190	19,0 cm / 7 1/2"
--------------------	------------------

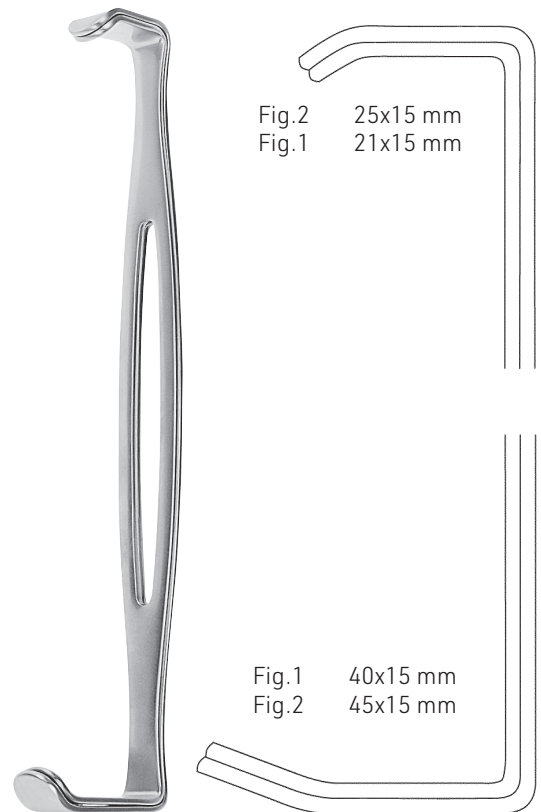

PARKER-LANGENBECK

016-474-000	21,5 cm / 8 1/2"	Fig.1-2
016-474-001	21,5 cm / 8 1/2"	Fig.1
016-474-002	21,5 cm / 8 1/2"	Fig.2



016

Wundhaken
Retractors
Separadores
Divaricatori



CRILE

016-478-110 11,0 cm / 4¹/₄"



LUER

016-479-110 11,0 cm / 4¹/₄"



COLLIN

016-480-145 14,5 cm / 5³/₄"



REVERDIN

016-485-290 29,0 cm / 11 1/2"



REVERDIN

016-486-280 28,5 cm / 11"



biegsam
 malleable
 maleable
 malleabile

RIBBON

016-490-030 330x30 mm
016-490-040 330x40 mm
016-490-050 330x50 mm



biegsam
 malleable
 maleable
 malleabile

HABERER

016-492-200 200x17/25 mm
016-492-280 280x25/30 mm
016-492-300 300x37/45 mm



biegsam
 malleable
 maleable
 malleabile

RIBBON

016-494-012 200x12 mm
016-494-017 200x17 mm
016-494-025 200x25 mm



016

Wundspreizer
Self-Retaining Retractors
Separadores autoestáticos
Divaricatori autostatici



FINSEN

016-500-005 - 016-501-005 5,0 cm / 2"
016-500-007 - 016-501-007 7,0 cm / 2³/₄"

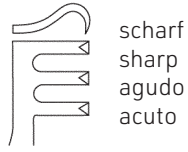

scharf
sharp
agudo
acuto

016-500-005

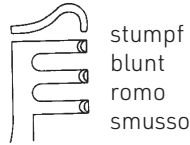

stumpf
blunt
romo
smusso

016-501-005

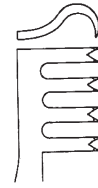

scharf
sharp
agudo
acuto

016-500-007

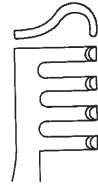

stumpf
blunt
romo
smusso

016-501-007

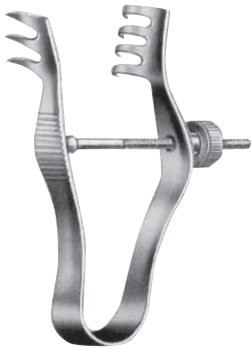

FINSEN

016-504-007 - 016-505-007 7,0 cm / 2³/₄"

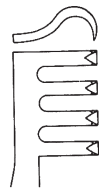

016-504-007

scharf
sharp
agudo
acuto

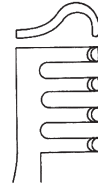

016-505-007

stumpf
blunt
romo
smusso

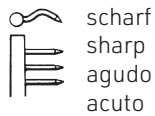
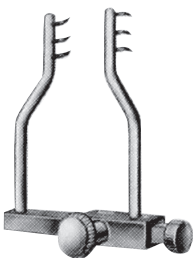

scharf
sharp
agudo
acuto

LOGAN

016-506-004 4,0 cm / 1¹/₂"

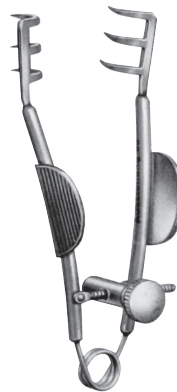

scharf
sharp
agudo
acuto

BUCKLEY

016-508-006 6,0 cm / 2¹/₄"

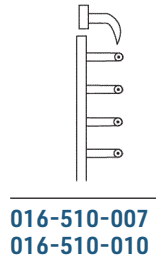

scharf
sharp
agudo
acuto

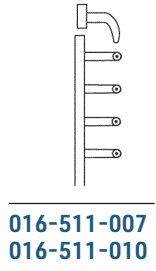

stumpf
blunt
romo
smusso

ALM

016-510-007 - 016-511-007 7,0 cm / 2³/₄"
 016-510-010 - 016-511-010 10,0 cm / 4"



ALLPORT

016-512-095 9,5 cm / 3³/₄"



scharf
sharp
agudo
acuto



stumpf
blunt
romo
smusso

HOLZHEIMER

016-514-010 - 016-515-010 10,0 cm / 4"

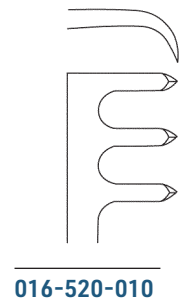

scharf
sharp
agudo
acuto

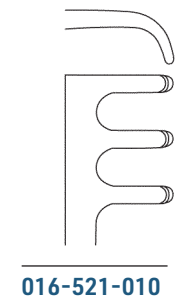

stumpf
blunt
romo
smusso

JANSEN

016-520-010 - 016-521-010 10,0 cm / 4"



016

Wundspreizer
Self-Retaining Retractors
Separadores autoestáticos
Divaricatori autostatici

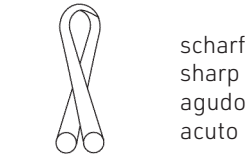

016-524-140

scharf
sharp
agudo
acuto

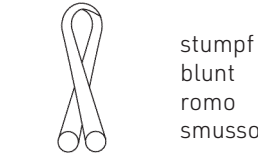

016-525-140

stumpf
blunt
romo
smusso

SCALP-CONTOUR

016-524-140 - 016-525-140 14,0 cm / 5 1/2"

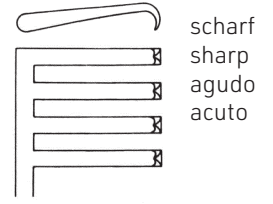

scharf
sharp
agudo
acuto

ANDERSON-ADSON

016-530-195 20,0 cm / 8"

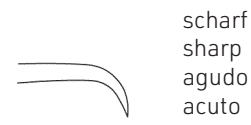

016-532-265

scharf
sharp
agudo
acuto

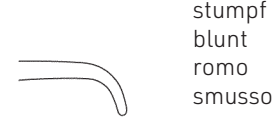

016-533-265

stumpf
blunt
romo
smusso

ADSON

016-532-265 - 016-533-265 26,5 cm / 10 1/2"

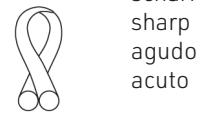
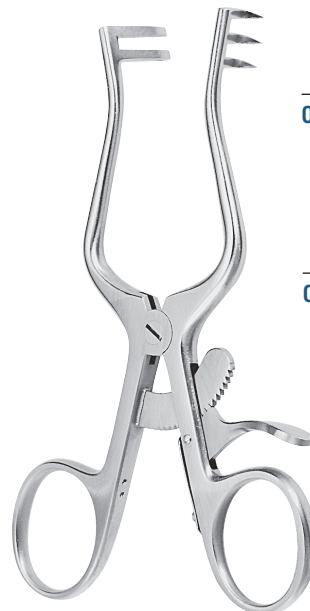

016-538-105

scharf
sharp
agudo
acuto



016-539-105

stumpf
blunt
romo
smusso

WEITLANER-LOKTITE

016-538-105 - 016-539-105 10,5 cm / 4 1/8"

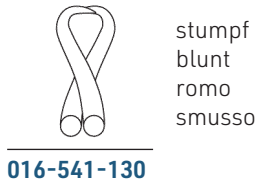
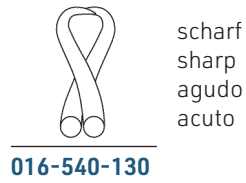

WEITLANER

016-540-130 - 016-541-130 13,0 cm / 5 1/8"

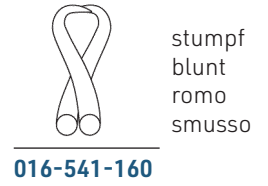
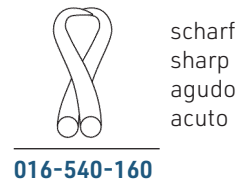

WEITLANER

016-540-160 - 016-541-160 16,0 cm / 6 1/4"



WEITLANER

016-540-200 - 016-541-200 20,0 cm / 8"



WEITLANER

016-540-240 - 016-541-240 24,0 cm / 9 1/2"

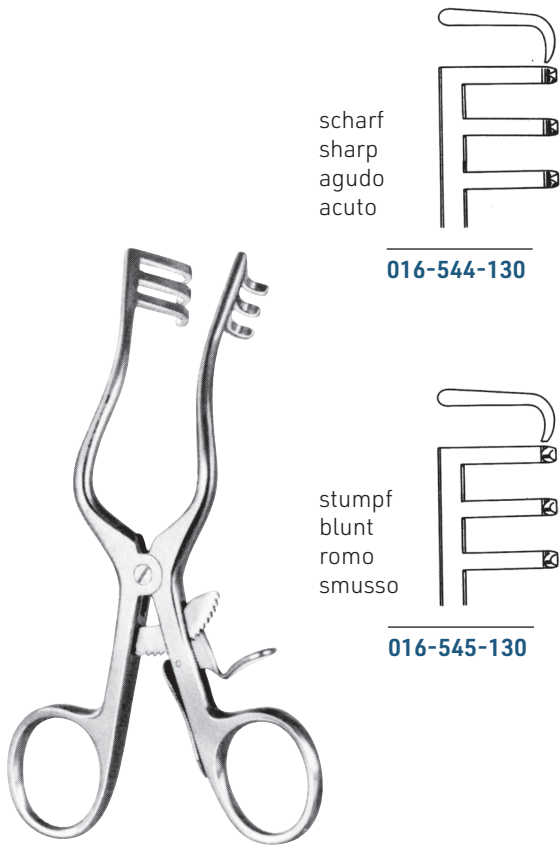

scharf
sharp
agudo
acuto

016-544-130

stumpf
blunt
romo
smusso

016-545-130

WEITLANER-WULLSTEIN

016-544-130 - 016-545-130 13,0 cm / 5"

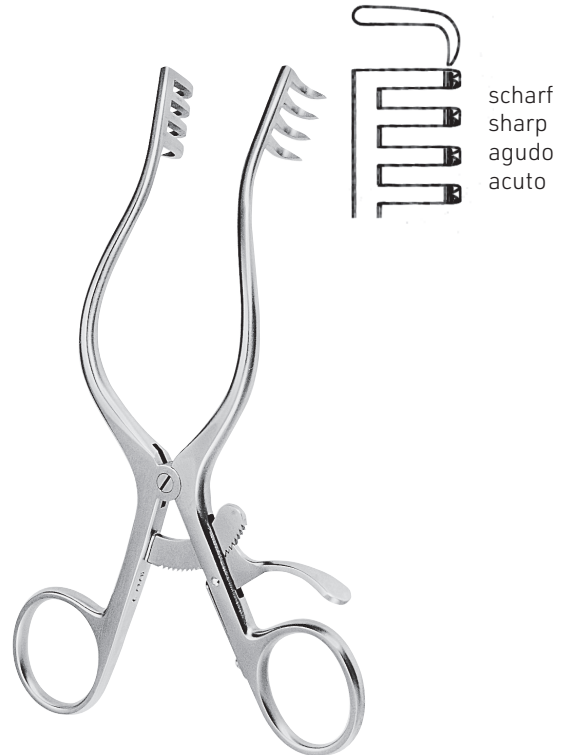

scharf
sharp
agudo
acuto

MOLLISON

016-550-155 15,5 cm / 6"

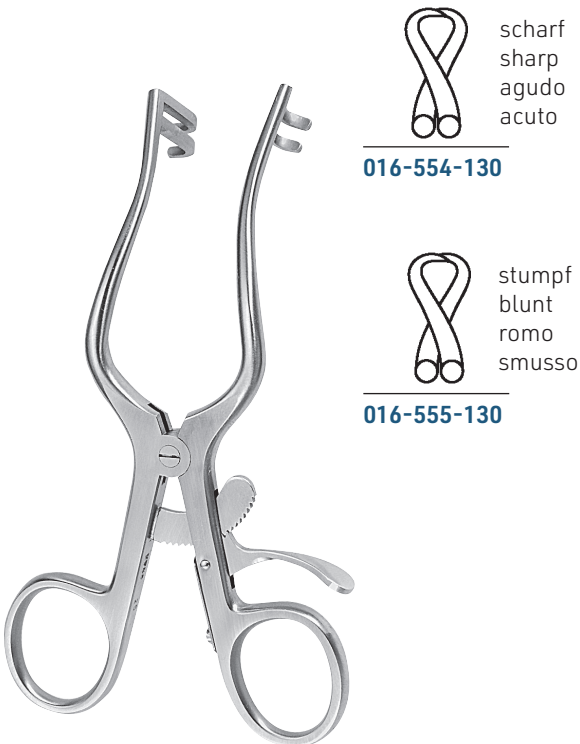

scharf
sharp
agudo
acuto

016-554-130

stumpf
blunt
romo
smusso

016-555-130



PLESTER

016-554-130 - 016-555-130 13,0 cm / 5"

PLESTER

016-556-110 11,0 cm / 4³/₈"

PLESTER

016-557-110 11,0 cm / 4³/₈"

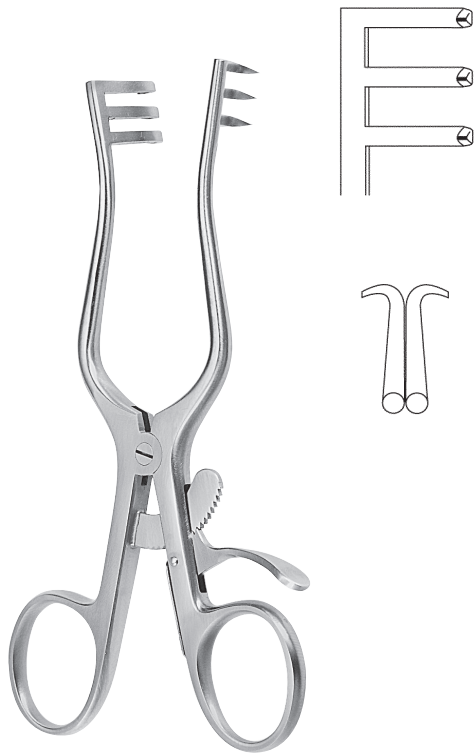

stumpf
 blunt
 romo
 smusso

MILLIGAN

016-560-130 13,0 cm / 5"



WEITLANER-BABY

016-562-130 13,0 cm / 5"



scharf
 sharp
 agudo
 acuto

016-564-125

stumpf
 blunt
 romo
 smusso

016-565-125

SCHUKNECHT

016-564-125 - 016-565-125 12,5 cm / 5"

scharf
sharp
agudo
acuto



016-572-019 19x16 mm

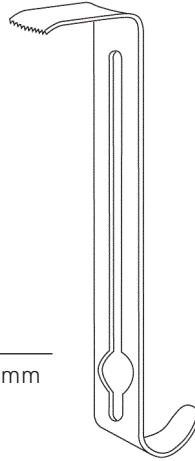

016-572-025 25x16 mm

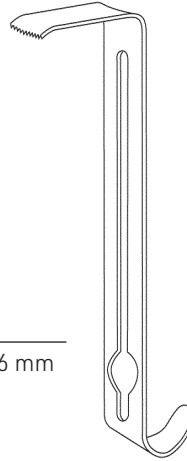

016-572-032 32x16 mm

stumpf
blunt
romo
smusso



HENLEY

016-570-000 16,0 cm / 6 1/4"

HENLEY

016-570-000

komplett, bestehend aus:

- 1 Sperrer mit Seitenvälvn, scharf (016-570-001)
- 1 Mittelvalve 19 x 16 mm (016-572-019)
- 1 Mittelvalve 25 x 16 mm (016-572-025)
- 1 Mittelvalve 32 x 16 mm (016-572-032)

complete, consisting of:

- 1 Spreader with lateral valves, sharp (016-570-001)
- 1 Central valve 19 x 16 mm (016-572-019)
- 1 Central valve 25 x 16 mm (016-572-025)
- 1 Central valve 32 x 16 mm (016-572-032)

completo, compuesto de:

- 1 Separador con valvas laterales, agudas (016-570-001)
- 1 Valva central 19 x 16 mm (016-572-019)
- 1 Valva central 25 x 16 mm (016-572-025)
- 1 Valva central 32 x 16 mm (016-572-032)

completo, composto da:

- 1 Divaricatore con valve laterali, acuto (016-570-001)
- 1 Valva centrale 19 x 16 mm (016-572-019)
- 1 Valva centrale 25 x 16 mm (016-572-025)
- 1 Valva centrale 32 x 16 mm (016-572-032)

HENLEY

016-571-000 16,0 cm / 6 1/4"

HENLEY

016-571-000

komplett bestehend aus:

- 1 Sperrer mit Seitenvälvn, stumpf (016-571-001)
- 1 Mittelvalve 19 x 16 mm (016-572-019)
- 1 Mittelvalve 25 x 16 mm (016-572-025)
- 1 Mittelvalve 32 x 16 mm (016-572-032)

complete consisting of:

- 1 Spreader with lateral valves, blunt (016-571-001)
- 1 Central valve 19 x 16 mm (016-572-019)
- 1 Central valve 25 x 16 mm (016-572-025)
- 1 Central valve 32 x 16 mm (016-572-032)

completo, compuesto de:

- 1 Separador con valvas laterales, romas (016-571-001)
- 1 Valva central 19 x 16 mm (016-572-019)
- 1 Valva central 25 x 16 mm (016-572-025)
- 1 Valva central 32 x 16 mm (016-572-032)

completo, composto da:

- 1 Divaricatore con valve laterali, smusso (016-571-001)
- 1 Valva centrale 19 x 16 mm (016-572-019)
- 1 Valva centrale 25 x 16 mm (016-572-025)
- 1 Valva centrale 32 x 16 mm (016-572-032)



scharf
sharp
agudo
acuto

ADSON

016-580-130 13,5 cm / 5¹/₄"
016-580-160 16,5 cm / 6¹/₂"



stumpf
blunt
romo
smusso

ADSON

016-581-130 13,5 cm / 5¹/₄"
016-581-160 16,5 cm / 6¹/₂"



016

Wundspreizer
Self-Retaining Retractors
Separadores autoestáticos
Divaricatori autostatici

scharf
sharp
agudo
acuto

stumpf
blunt
romo
smusso



ADSON

016-580-200 20,0 cm / 8"
016-580-260 26,0 cm / 10¹/₄"

ADSON

016-581-200 20,0 cm / 8"
016-581-260 26,0 cm / 10¹/₄"

scharf
sharp
agudo
acuto

stumpf
blunt
romo
smusso



BECKMANN

016-590-320 32,0 cm / 12¹/₂"



ADSON

016-592-330 33,0 cm / 13"

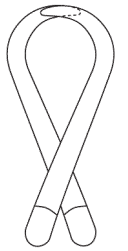



016

Wundspreizer
Self-Retaining Retractors
Separadores autoestáticos
Divaricatori autostatici



BECKMANN-EATON

016-594-320 32,0 cm / 12¹/₂"



BECKMANN-ADSON

016-596-001 - 016-598-002 30,5 cm / 12¹/₄"



scharf
sharp
agudo
acuto

016-596-001 25x25 mm
016-598-001 25x45 mm



stumpf
blunt
rombo
smusso

016-596-002 25x25 mm
016-598-002 25x45 mm

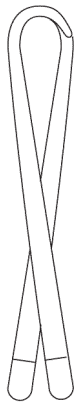

NORFOLK AND NORWICH

016-600-220 22,0 cm / 8³/₄"



RICHTER

016-620-170 17,0 cm / 6³/₄"



MAYO-ADAMS

016-622-165 16,5 cm / 6 1/2"



RIGBY

016-626-180 18,0 cm / 7"



JOLL (FRIEDMAN)

016-630-155 15,5 cm / 6"



GELPI

016-640-090 9,0 cm / 3¹/₂"
016-640-110 11,0 cm / 4³/₈"



GELPI

016-640-130 13,0 cm / 5³/₈"



GELPI

016-640-160 16,0 cm / 6¹/₄"
016-640-180 18,0 cm / 7"



GELPI-LOKTITE

016-641-180 18,0 cm / 7"



016

Wundspreizer für die cervicale Wirbelsäule
Retractors for cervical spine
Separadores para la columna cervical
Divaricatori per colonna cervicale

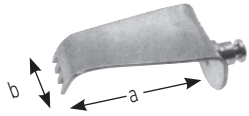

016-650-040 40x15-23 mm (axb)



016-650-045 45x15-23 mm (axb)



016-650-050 50x15-23 mm (axb)



016-650-055 55x15-23 mm (axb)



016-650-060 60x15-23 mm (axb)

CLOWARD

016-650-000

Wundspreizer, komplett, bestehend aus:

- 1 Sperrer (016-650-001)
- 2 gezahnten Seitenvalven 40x15 - 23 mm (016-650-040)
- 2 gezahnten Seitenvalven 45x15 - 23 mm (016-650-045)
- 2 gezahnten Seitenvalven 50x15 - 23 mm (016-650-050)
- 2 gezahnten Seitenvalven 55x15 - 23 mm (016-650-055)
- 2 gezahnten Seitenvalven 60x15 - 23 mm (016-650-060)

Self-retaining retractor, complete, consisting of:

- 1 Spreader (016-650-001)
- 2 Lateral valves, serrated, 40x15 - 23 mm (016-650-040)
- 2 Lateral valves, serrated, 45x15 - 23 mm (016-650-045)
- 2 Lateral valves, serrated, 50x15 - 23 mm (016-650-050)
- 2 Lateral valves, serrated, 55x15 - 23 mm (016-650-055)
- 2 Lateral valves, serrated, 60x15 - 23 mm (016-650-060)

Separador, completo, compuesto de:

- 1 Separador (016-650-001)
- 2 Valvas laterales, dentadas, 40x15 - 23 mm (016-650-040)
- 2 Valvas laterales, dentadas, 45x15 - 23 mm (016-650-045)
- 2 Valvas laterales, dentadas, 50x15 - 23 mm (016-650-050)
- 2 Valvas laterales, dentadas, 55x15 - 23 mm (016-650-055)
- 2 Valvas laterales, dentadas, 60x15 - 23 mm (016-650-060)

Divaricatore, completo, composto da:

- 1 Divaricatore (016-650-001)
- 2 Valve laterale, dentellata, 40x15 - 23 mm (016-650-040)
- 2 Valve laterale, dentellata, 45x15 - 23 mm (016-650-045)
- 2 Valve laterale, dentellata, 50x15 - 23 mm (016-650-050)
- 2 Valve laterale, dentellata, 55x15 - 23 mm (016-650-055)
- 2 Valve laterale, dentellata, 60x15 - 23 mm (016-650-060)



CLOWARD

016-650-001 25,0 cm / 9³/₄"

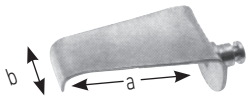

016-660-040 40x15-23 mm (axb)



016-660-045 45x15-23 mm (axb)



016-660-050 50x15-23 mm (axb)



016-660-055 55x15-23 mm (axb)



016-660-060 60x15-23 mm (axb)

CLOWARD

016-660-000

Wundspreizer, komplett, bestehend aus:

- 1 Sperrer (016-660-001)
- 2 stumpfen Seitenvalven 40x15 - 23 mm (016-660-040)
- 2 stumpfen Seitenvalven 45x15 - 23 mm (016-660-045)
- 2 stumpfen Seitenvalven 50x15 - 23 mm (016-660-050)
- 2 stumpfen Seitenvalven 55x15 - 23 mm (016-660-055)
- 2 stumpfen Seitenvalven 60x15 - 23 mm (016-660-060)

Self-retaining retractor, complete, consisting of:

- 1 Spreader (016-660-001)
- 2 Lateral valves, blunt, 40x15 - 23 mm (016-660-040)
- 2 Lateral valves, blunt, 45x15 - 23 mm (016-660-045)
- 2 Lateral valves, blunt, 50x15 - 23 mm (016-660-050)
- 2 Lateral valves, blunt, 55x15 - 23 mm (016-660-055)
- 2 Lateral valves, blunt, 60x15 - 23 mm (016-660-060)

Separador, completo, compuesto de:

- 1 Separador (016-660-001)
- 2 Valvas laterales, romas, 40x15 - 23 mm (016-660-040)
- 2 Valvas laterales, romas, 45x15 - 23 mm (016-660-045)
- 2 Valvas laterales, romas, 50x15 - 23 mm (016-660-050)
- 2 Valvas laterales, romas, 55x15 - 23 mm (016-660-055)
- 2 Valvas laterales, romas, 60x15 - 23 mm (016-660-060)

Divaricatore, completo, composto da:

- 1 Divaricatore (016-660-001)
- 2 Valve laterale, smussa, 40x15 - 23 mm (016-660-040)
- 2 Valve laterale, smussa, 45x15 - 23 mm (016-660-045)
- 2 Valve laterale, smussa, 50x15 - 23 mm (016-660-050)
- 2 Valve laterale, smussa, 55x15 - 23 mm (016-660-055)
- 2 Valve laterale, smussa, 60x15 - 23 mm (016-660-060)



CLOWARD

016-660-001 15,0 cm / 6"



016

Wundspreizer, Bauchdeckenhalter
Self-Retaining Retractors, Abdominal Retractors
Separadores autoestáticos, Separadores abdominales
Divaricatori autostatici, Divaricatori addominali



016-670-030 30x44 mm



016-670-023 23x44 mm

Wechselvalven
Exchangeable blades
Valvas intercambiabiles
Valve intercambiabili

BABY-COLLIN

016-670-000 18,0 cm / 7"



COLLIN

016-680-000 22,5 cm / 9"



COLLIN

016-682-000 22,5 cm / 9¹/₄"



COLLIN-LOKTITE

016-684-000 31,0 cm / 12¹/₄"

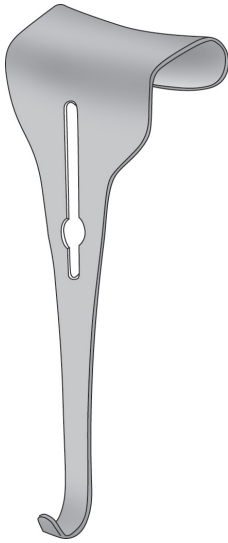

COLLIN

016-686-055	55x55 mm
016-686-065	55x65 mm
016-686-075	55x75 mm

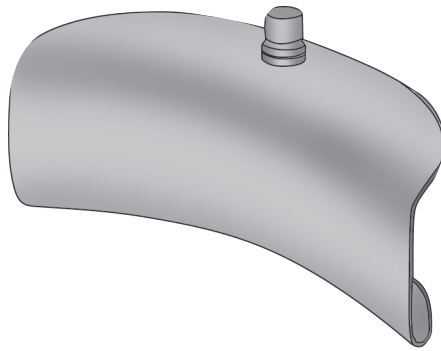

016-688-001	32x 62 mm
016-688-002	38x 80 mm
016-688-003	38x100 mm

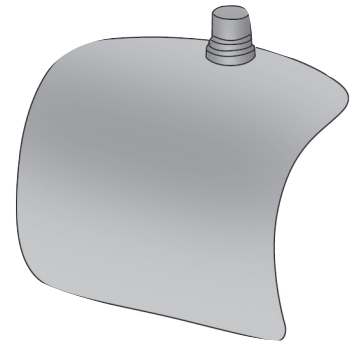

016-688-004	60x80 mm
--------------------	----------



RICARD

016-711-001	55x70 mm
016-711-002	90x80 mm



016-713-050	50x58 mm
016-713-060	60x80 mm
016-713-072	72x85 mm

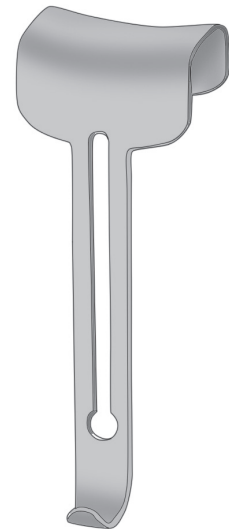

ROBIN-MASSE

016-721-001	40x64 mm
--------------------	----------



016

Wundspreizer, Bauchdeckenhalter
Self-Retaining Retractors, Abdominal Retractors
Separadores autoestáticos, Separadores abdominales
Divaricatori autostatici, Divaricatori addominali

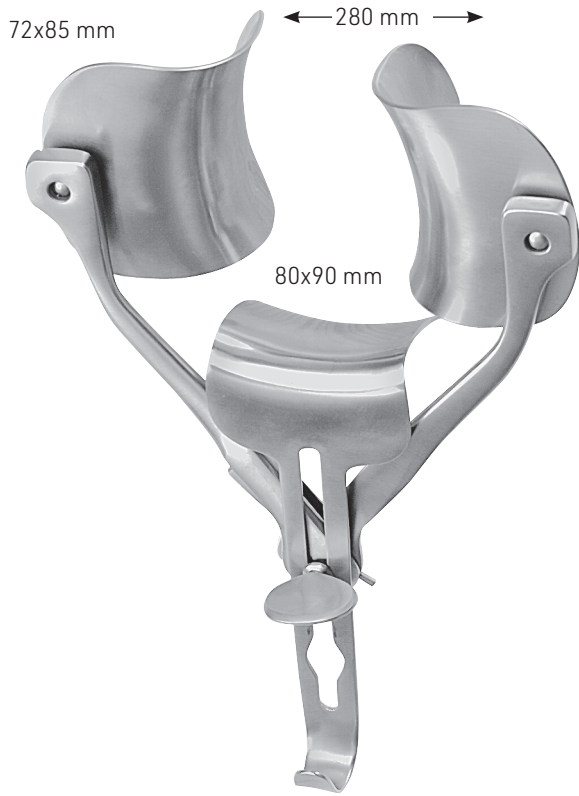

RICARD

016-700-280 28,0 cm / 11"

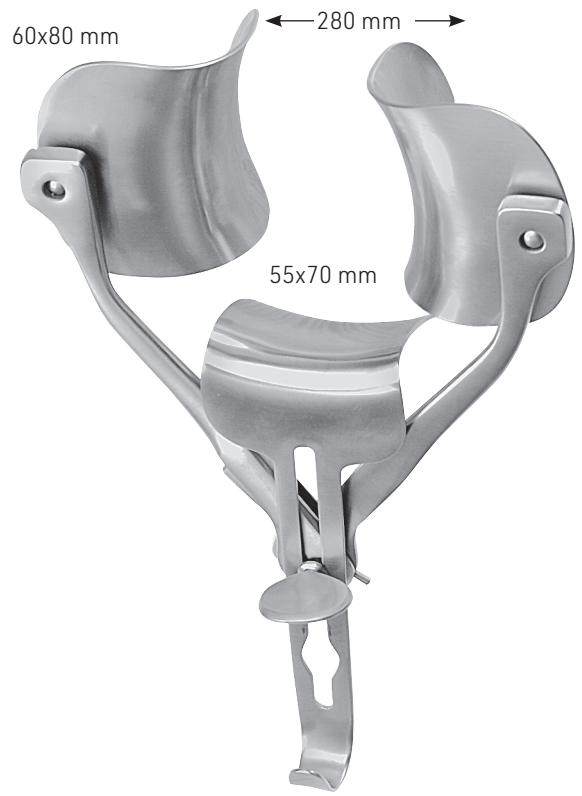

RICARD

016-710-300 30,0 cm / 12"



ROBIN-MASSE

016-720-270

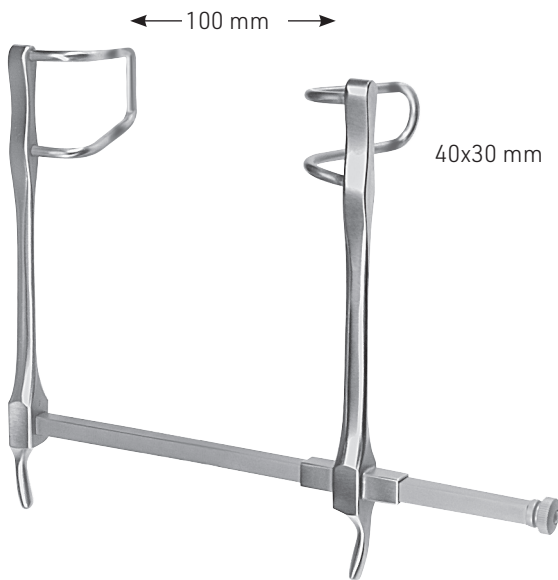

GOSSET
016-730-100

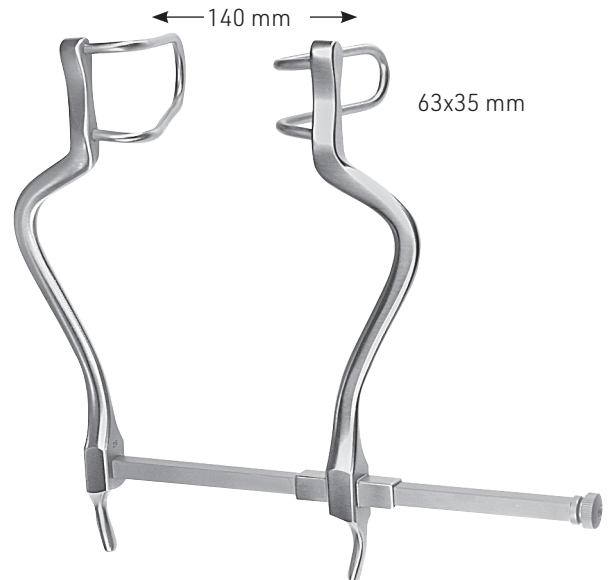

GOSSET
016-730-140

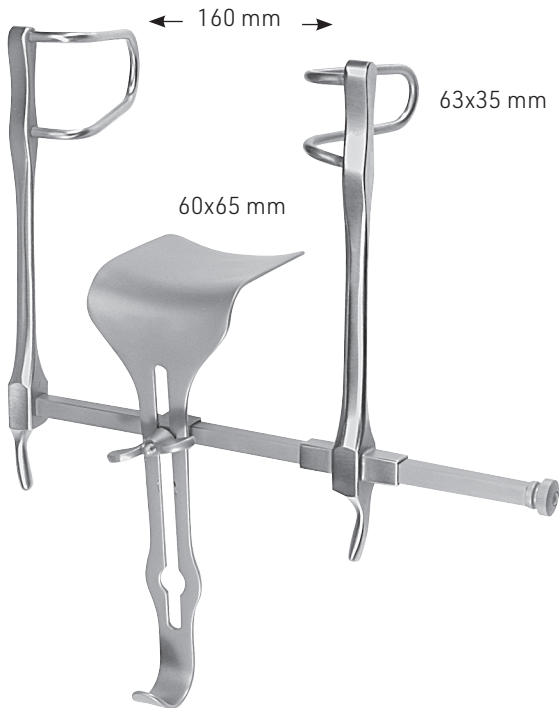

GOSSET
016-731-060

016-731-060 60x65 mm
 Mittelvalve
 Central blade
 Valva central
 Valva centrale

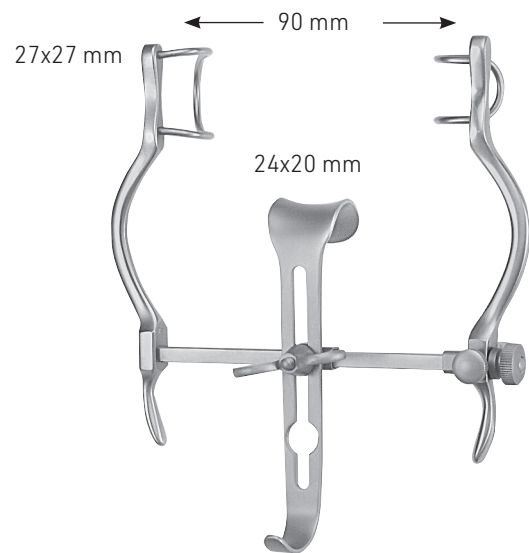

BABY-BALFOUR
016-740-090



016

Bauchdeckenhalter
Abdominal Retractors
Separadores abdominales
Divaricatori addominali

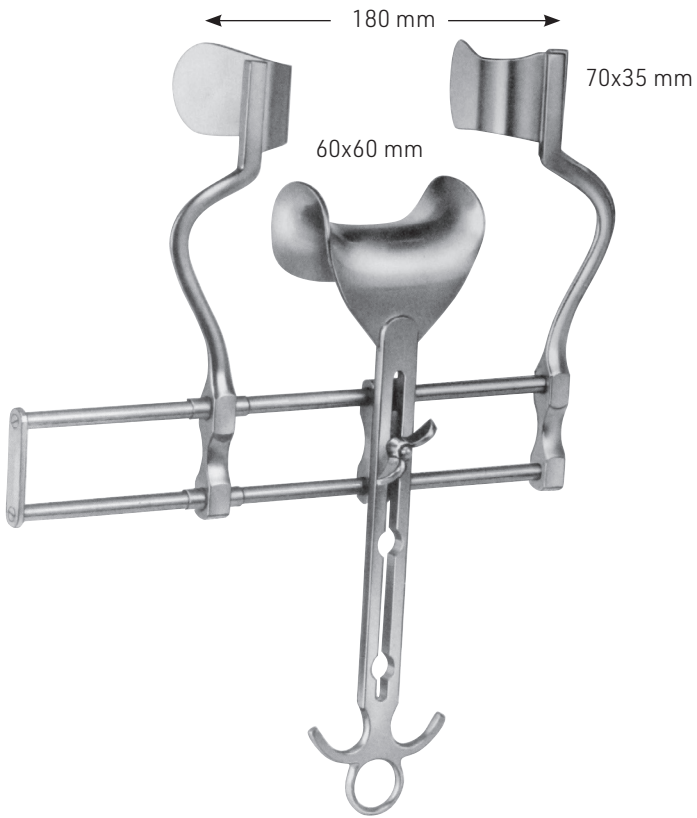

BALFOUR
016-746-180

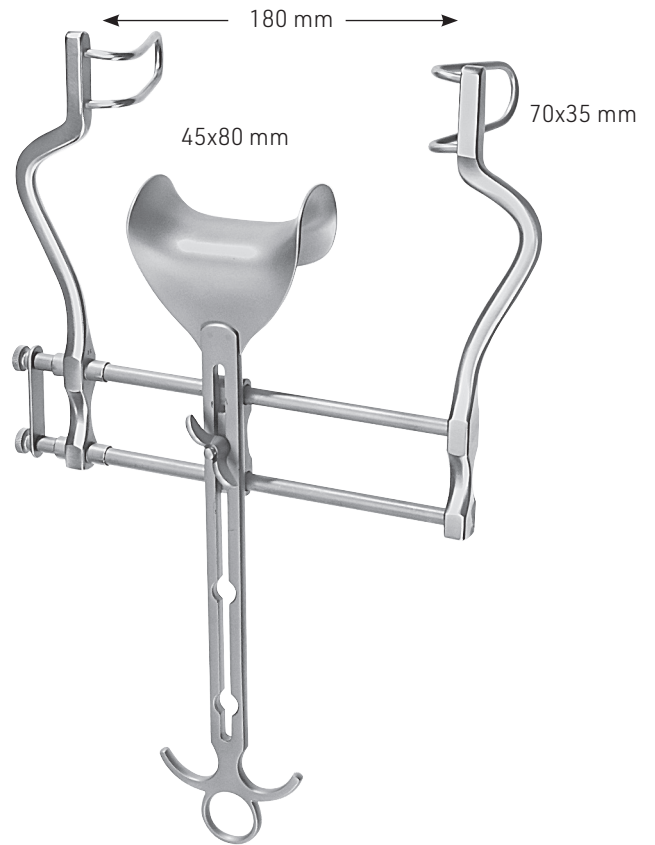

BALFOUR
016-750-180

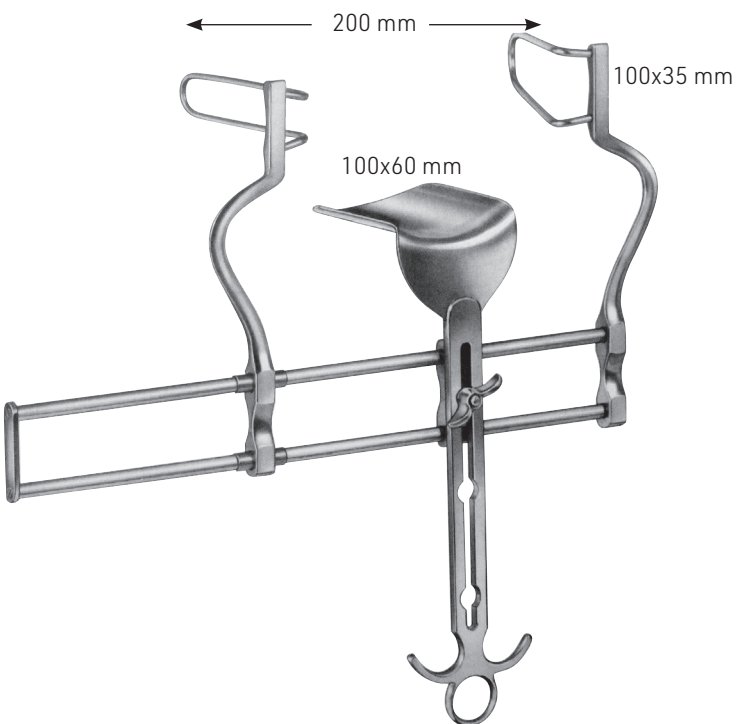

BALFOUR
016-750-200

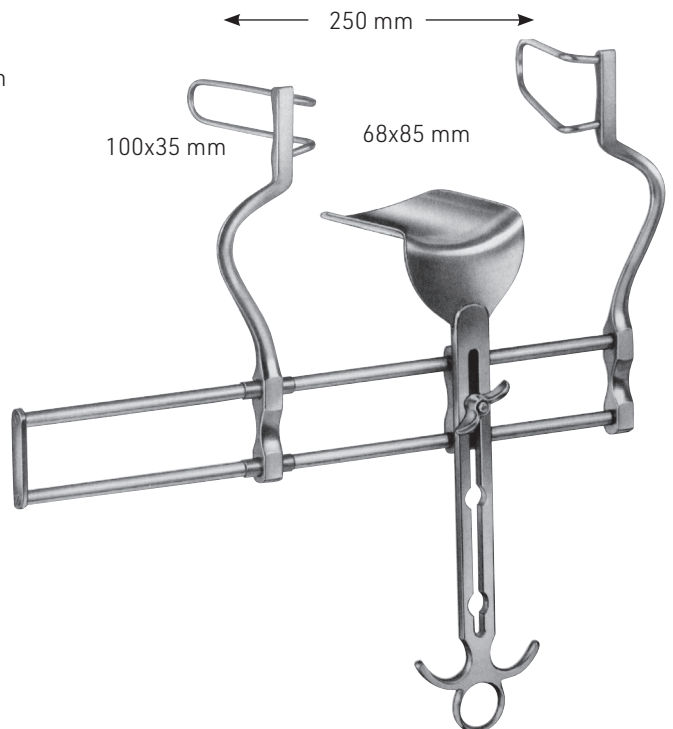

BALFOUR
016-750-250

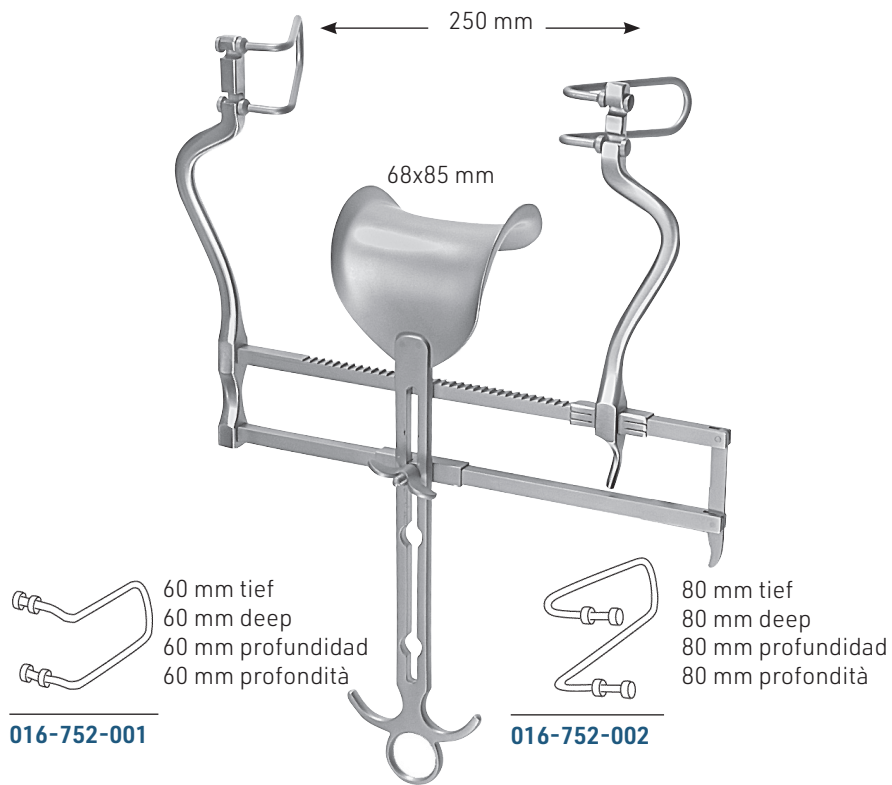

BALFOUR US-TYPE

016-752-000

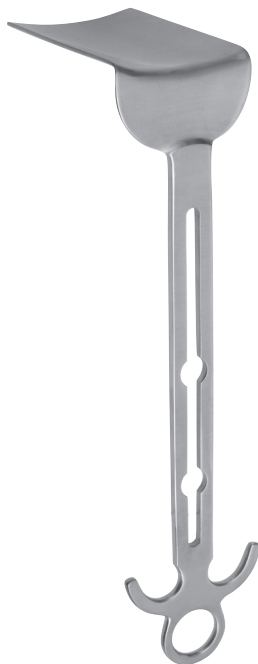

BALFOUR

016-756-100 100x60 mm

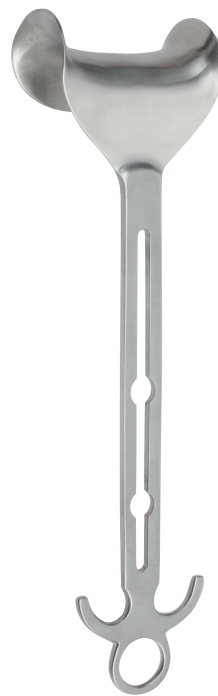

BALFOUR

016-758-001 45x80 mm
016-758-002 68x85 mm



016

Bauchdeckenhalter
Abdominal Retractors
Separadores abdominales
Divaricatori addominali

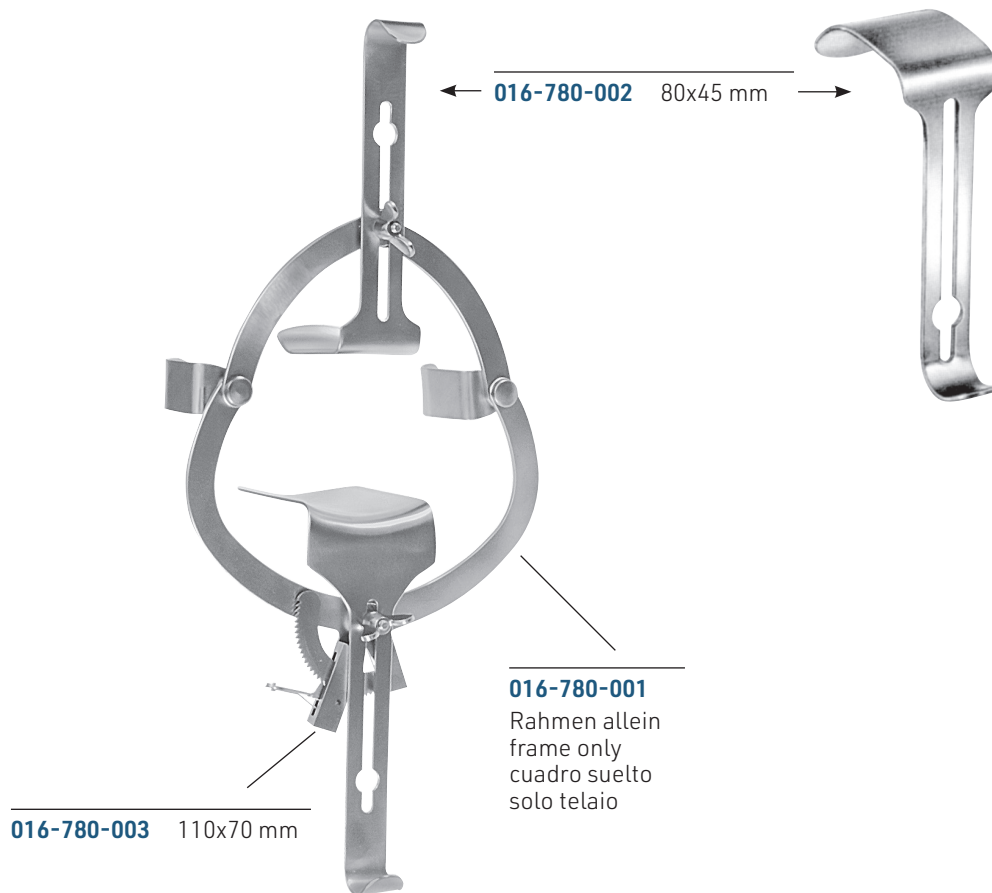

O`SULLIVAN-O`CONNOR

016-780-000

komplett, complete, completo, completo
1 x 016-780-001
2 x 016-780-002
1 x 016-780-003

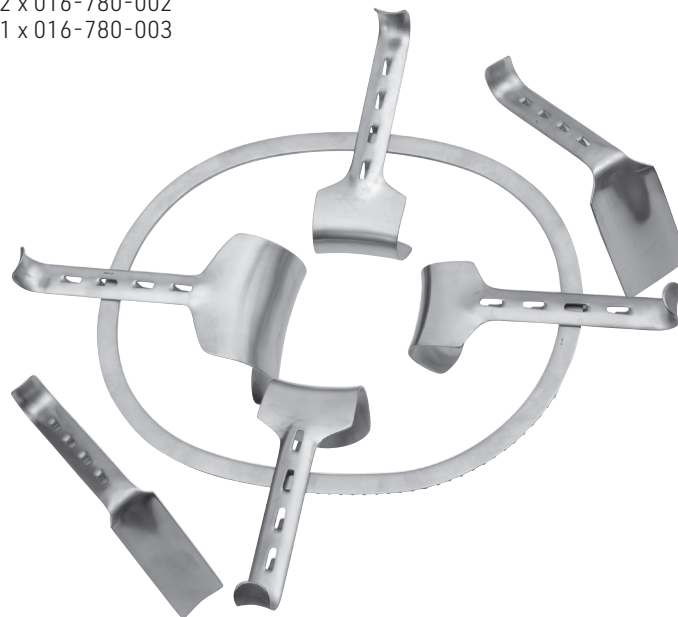

KIRSCHNER

016-800-000

komplett, complete, completo, completo
1 x 016-800-001
3 x 016-811-002
1 x 016-811-003
1 x 016-813-001
1 x 016-813-002

016-800-001 300 x 240 mm

Rahmen allein
frame only
cuadro suelto
telaio solo

016-811-002 50x65 mm

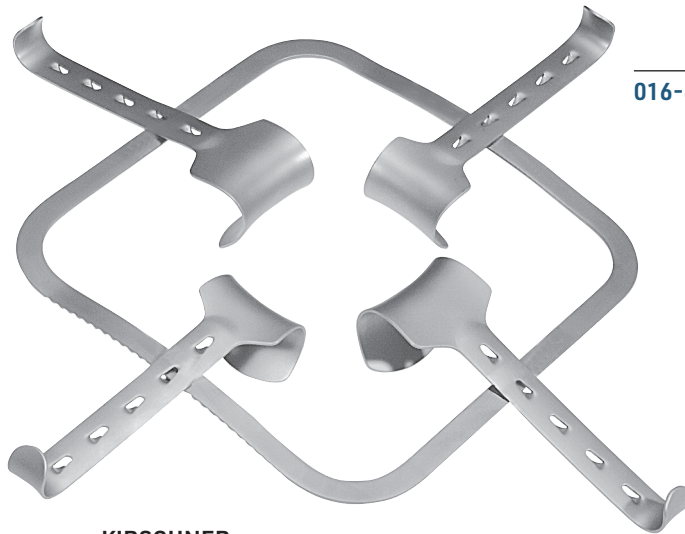

016-811-001 40x55 mm

016-810-001 240x240 mm

Rahmen allein
frame only
cuadro suelto
telaio solo

KIRSCHNER

016-810-000

komplett, complete, completo, completo
1 x 016-810-001
2 x 016-811-001
2 x 016-811-002



KIRSCHNER

016-811-003 80x90 mm
016-811-004 90x65 mm



KIRSCHNER

016-811-005 60x85 mm



KIRSCHNER-BALFOUR

016-811-010 80x80 mm



KIRSCHNER

016-813-001 98x50 mm
016-813-002 105x35 mm

KIRSCHNER

016-814-000 270x270 mm
komplett, complete, completo, completo
1 x 016-814-001
2 x 016-811-001
2 x 016-811-002

016-814-001 270x270 mm

zusammenlegbarer Rahmen, allein
folding frame, only
cuadro plegable, suelto
telaio pieghevole, solo





016

Bauchdeckenhalter
Abdominal Retractors
Separadores abdominales
Divaricatori addominali

016-820-004 83x94 mm

016-820-005 45x57 mm

016-820-001 275x250 mm

Rahmen allein
frame only
cuadro suelto
telaio solo

016-820-002 98x50 mm

016-820-003 105x35 mm

SEMM

016-820-000

komplett, complete, completo, completo

1 x 016-820-001

1 x 016-820-002

1 x 016-820-003

1 x 016-820-004

2 x 016-820-005

1 x 016-820-006

016-820-006 50x54 mm

016-832-004 40x40 mm

016-832-003 40x30 mm

016-831-255 255x180 mm

016-831-150 150x180 mm

Rahmen allein
frame only
cuadro suelto
telaio solo

40x40 mm

DENIS-BROWNE

016-830-150

1 x 016-831-150

2 x 016-832-003

2 x 016-832-004

DENIS-BROWNE

016-830-255

1 x 016-831-255

2 x 016-832-003

2 x 016-832-004

016-832-001 20x30 mm

016-832-002 20x40 mm

016-840-004 40x60 mm

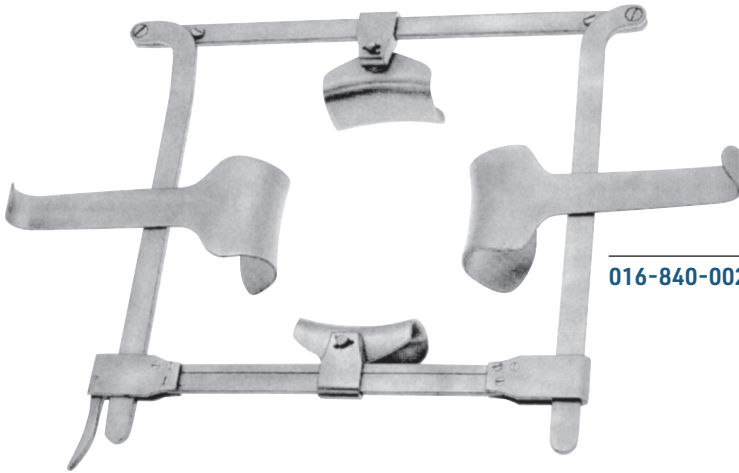

016-840-002 48x56 mm

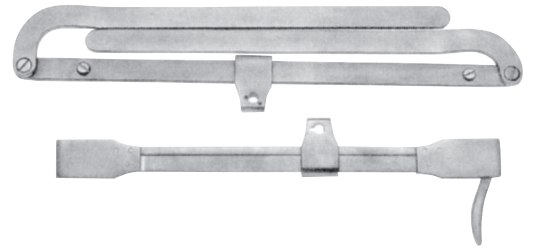

016-840-001 220x220 mm
zusammenlegbarer Rahmen, allein
folding frame, only
cuadro plegable, suelto
telaiο piegabile, solo

FRANZ

016-840-000

komplett, complete, completo, completo

- 1 x 016-840-001
- 2 x 016-840-002
- 2 x 016-840-004

FRANZ

016-842-000

komplett, complete, completo, completo

- 1 x 016-840-001
- 2 x 016-840-002
- 2 x 016-840-003
- 2 x 016-840-004
- 2 x 016-840-005



016-840-004 40x60 mm
016-840-005 40x80 mm

016-840-002 48x56 mm
016-840-003 50x85 mm



DOYEN

- 016-850-001** 28,0 cm /11" 90x50 mm
- 016-850-002** 28,0 cm /11" 105x50 mm
- 016-850-003** 28,0 cm /11" 120x50 mm
- 016-850-004** 28,0 cm /11" 135x50 mm



Kette mit Gewicht
Chain with weight
Cadena con peso
Catena con peso

016-851-000 79,0 cm /31"



016

Bauchdeckenhalter
Abdominal Retractors
Separadores abdominales
Divaricatori addominali



ROCHARD
016-860-000



ROCHARD
016-870-000



ROCHARD
016-871-001 19,0 cm / 11"

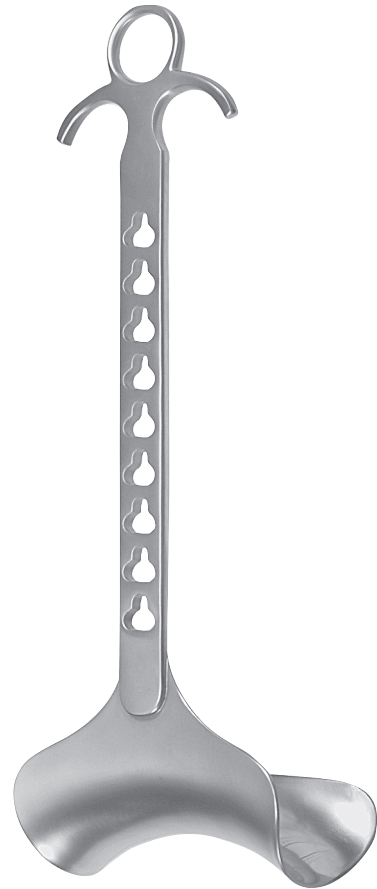

ROCHARD

016-871-002	28,0 cm / 11"	95x50 mm
016-871-003	28,0 cm / 11"	105x50 mm
016-871-004	28,0 cm / 11"	120x60 mm
016-871-005	28,0 cm / 11"	135x60 mm
016-871-006	28,0 cm / 11"	155x60 mm